

## Instructions for use



CE

assistina

3x3 (MB-300)

3x2 (MB-200)

# Contents

---

W&H Symbols .....	5 – 7
1. Introduction .....	8 – 10
2. Electromagnetic compatibility (EMC) .....	11
3. Unpacking .....	12
4. Scope of delivery .....	13
5. Safety notes .....	14 – 15
6. Description .....	16 – 21
> Front panel and LED displays [16]	
> External cleaning ring for Assistina 3x3 [17]	
> RM/ISO adaptor [18]	
> Process chamber [19]	
> Cartridge compartment [20],	
> Rear panel [21]	
7. Starting operation .....	22 – 29
> Insertion/removal of a cartridge [22]	
> Insertion/removal of an external cleaning ring [23 – 24]	
> Connection/disconnection of the air connecting hose [25]	
> Connection of the mains cable [26]	
> Switch on / switch off Assistina [26]	
> Initial filling [27]	
> Standby mode [28]	
> Test run [29]	

# Contents

---

8.	Hygiene and maintenance.....	30 – 36
	> General information {30}	
	> Description of the process {31}	
	> Description of the adaptors {32}	
	> Connection/disconnection of the adaptors {33}	
	> Loading/removing transmission instruments with ISO and Roto Quick connections {34}	
	> Loading/removing transmission instruments with a fixed RM connection {35}	
	> Preparation process (with time indication) {36}	
9.	Cleaning and disinfection .....	37 – 40
	> Device and RM/ISO adaptor {37 – 38}	
	> Waste drawer, cover, external cleaning ring {39}	
	> Start-up after cleaning and disinfection {39 – 40}	
10.	Maintenance.....	41 – 43
	> Emptying the waste drawer {41}	
	> Replacing O-rings {42}	
	> Replacing the air filter {43}	

# Contents

---

11. Error messages .....	44 – 48
12. W&H Accessories .....	49 – 51
13. Servicing .....	52
14. Technical data .....	53 – 54
15. Recycling and disposal .....	55
Explanation of warranty terms .....	56
Authorized W&H service partners .....	57

# W&H Symbols

---

Symbols in the instructions for use



**WARNING!**  
[risk of injury]



**ATTENTION!**  
[to prevent damage occurring]



General explanations,  
without risk to persons or objects



Sterilizable up to the  
stated temperature



W&H Service

# W&H symbols

---

## Symbols on the device



Consult instructions  
for use



Do not dispose of with  
domestic waste



Date of manufacture



Data matrix code for product  
identification e.g. for hygiene/  
maintenance processes

**REF** Catalogue number

**SN** Serial number

**V** Supply voltage of the unit

**AC** Alternating current

**VA** Electric power input of the unit

**A** Supply current

**Hz** Frequency of the alternating  
current

# W&H symbols

## Symbols on the packaging / cartridges



This way up



Fragile, handle with care



Keep away from rain



General symbol for recovery/  
recyclable



»Der Grüne Punkt«  
Identification mark of Duales  
System Deutschland AG

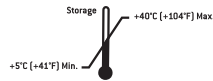

Temperature limit  
for storage

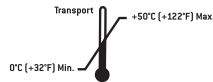

Temperature limit  
for transport

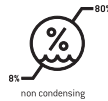

Humidity limitation



CE from  
manufacturer



Keep away from  
sunlight



Use by

**R**<sub>only</sub>

Federal law restricts this device to sale by or on the order of a dentist, physician or any other practitioner licensed by the law of the state in which he or she practices to use or order the use of the device.



**For your safety and the safety of your patients**

These instructions explain how to use your W&H product. However, we must also warn against possible hazardous situations. Your safety, the safety of your team and, of course, the safety of your patients, are of paramount importance to us.



It is therefore essential that you observe the safety notes on pages 14 – 15.

**Intended use**

The unit is a cleaning- and lubrication device for dental transmission instruments (especially straight- and contra angle handpieces, turbines, air-driven scalers and airmotors).

Misuse may damage the Assistina unit and hence cause risks and hazards for users and third parties.



When transmission instruments are prepared with the Assistina unit, they are neither disinfected nor sterilized. After cleaning and lubrication of the transmission instruments with the Assistina unit, they subsequently need to be disinfected and sterilized.



# Introduction

---

## Qualifications of the user

The Assistina unit is only intended for qualified use in dental medicine according to the applicable health and safety regulations and accident prevention measures, and with full compliance with these operating instructions. The Assistina must only be prepared and maintained by persons who have been instructed in infection protection, self-protection and patient safety. Improper use (e.g. due to lack of hygiene or appropriate maintenance), non-compliance with our instructions or the use of accessories and spare parts which have not been approved by W&H will invalidate all claims made under warranty or otherwise.

## Production according to EU Directive

 EU Directive 93/42/EEC has been used as a basis in the design and manufacture of this medical device and it applies to the dental surgical units

- > W&H Assistina 3x3 (external cleaning, internal cleaning and lubrication for up to 3 transmission instruments)
- > W&H Assistina 3x2 (internal cleaning and lubrication for up to 3 transmission instruments)

in the condition as supplied by us. This declaration does not apply to non-specified fittings, mountings etc.

# Introduction

---



## **Responsibility of the manufacturer**

The manufacturer can only accept responsibility for the safety, reliability and performance of the Assistina unit when it is used in compliance with the following directions:

- > The Assistina unit must be used in accordance with these instructions for use.
- > The Assistina unit has no components which can be repaired by the user (except replacing O-rings and the air filter). Assembly, modifications or repairs must only be undertaken by an authorized W&H service partner (see page 57).
- > The electrical installation at the premises must comply with the regulations of IEC 60364-7-710 («Installation of electrical equipment in rooms used for medical purposes») or with the regulations applicable in your country.
- > Unauthorized opening of the equipment invalidates all claims made under warranty and any other claims.

## 2. Electromagnetic compatibility (EMC)

---



### **Notes on electromagnetic compatibility (EMC)**

Medical electrical equipment is subject to particular precautions with respect to EMC and must be installed and put into operation in accordance with the included EMC instructions.

W&H guarantees the compliance of the device with the EMC requirements only when used with original W&H accessories and spare parts. The use of other accessories/spare parts can lead to increased emissions of electromagnetic interference or to a reduced resistance against electromagnetic interference.

### 3. Unpacking

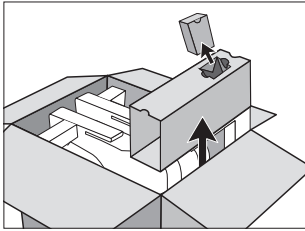

- Take out the carton with cartridge W&H Service Oil F1, MD-200.  
➤ Remove the spacer.

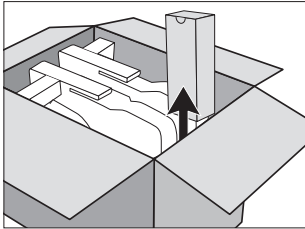

- Take out the carton with cartridge W&H Activefluid, MC-1100.

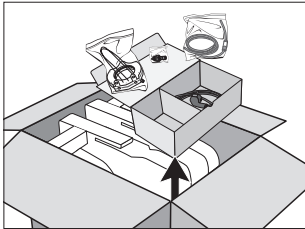

- Take out the carton containing the
  - Mains cable
  - Adaptor
  - Air connection hose
  - External cleaning ring (Assistina 3x3).

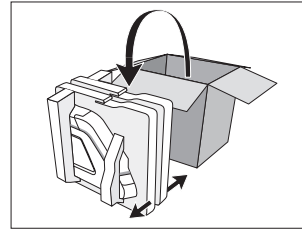

- Lift out the device.

W&H packaging is environmentally friendly and can be disposed of by industrial recycling companies.

However, we recommend that you keep the original packaging.

## 4. Scope of delivery

---

After unpacking, you should have the following parts:

### **W&H Assistina 3x3 (MB-300) REF 19923000**

- RM/ISO adaptor REF 06257600
- Air connection hose (2 m), REF 06700100
- W&H Service Oil F1, MD-200 REF 06691500
- W&H Activefluid, MC-1100 REF 06691600
- External cleaning ring REF 06692700

### **W&H Assistina 3x2 (MB-200) REF 19922000**

- RM/ISO adaptor REF 06257600
- Air connection hose (2 m), REF 06700100
- W&H Service Oil F1, MD-200 REF 06691500
- W&H Activefluid, MC-1100 REF 06691600

### **Mains cable for W&H Assistina 3x3 / 3x2**

- REF 01343700 (EU)

or:

REF 02821400 (USA, CAN, J) / REF 03212700 (UK, IRL) / REF 02909300 (AUS, NZ) / REF 04280600 (CH) /  
REF 05901800 (DK)

### **Optional for W&H Assistina 3x3 / 3x2**

- Adaptor for all W&H products with Roto Quick System, REF 02690400

## 5. Safety notes

---



### **Please observe the following instructions under all circumstances**

- > Before using the Assistina for the first time, store it at room temperature for 24 hours.
- > Always place the Assistina unit on a flat, level surface.
- > Only set up the device in a sufficiently well ventilated room.
- > Always ensure that the correct operating conditions are provided.
- > Before every use, check the device for damage, leaks and loose parts (e.g. adaptor, cover, external cleaning ring).
- > Before starting to use the device, always close the cover and waste drawer.
- > Keep the device closed during the preparation process.



### **Inappropriate use**

In addition to incorrect assembly, installation, modification or repairs to the Assistina unit or failure to comply with our instructions invalidates all claims under warranty and any other claims.

### **Mains cable**

Only use the mains cable supplied.



Set up the device so that the power cable is easily accessible.

In dangerous situations, the device can be disconnected from the power supply using the power cable.

### **Device**

The device is classed as »conventional equipment« (closed equipment without protection against the ingress of water).

# Safety notes

---

## External cleaning ring



### Risks due to magnetic fields

The functionality of implantable systems, such as cardiac pacemakers and ICD (implantable cardioverter defibrillator) can be affected by magnetic fields.

- > Keep the external cleaning ring away from implanted devices.

## Process fluids



- > After inhalation: Supply fresh air; consult doctor in case of complaints.
- > After skin contact: Wash off with soap and plenty of water.
- > After eye contact: Rinse opened eye for several minutes under running water.  
If symptoms persist, consult a doctor.
- > After swallowing: If symptoms persist, consult a doctor.
- > Only use process fluids which have been approved by the manufacturer.

### Approved process fluids

- > W&H Activefluid, MC-1100
- > W&H Service Oil F1, MD-200

## Cartridges



- > Replace a faulty or leaking cartridge immediately.
- > Protect the cartridges against direct sunlight.



The cartridge spike in the device is sharp.  
Be careful not to injure yourself on the projecting spike.

## 6. Description – front panel and LED displays

### Operating controls/LED displays

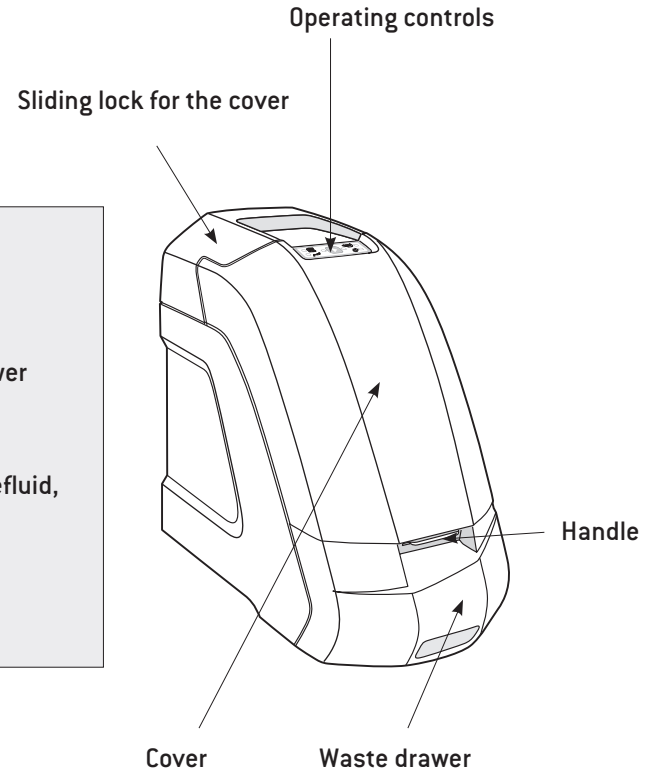
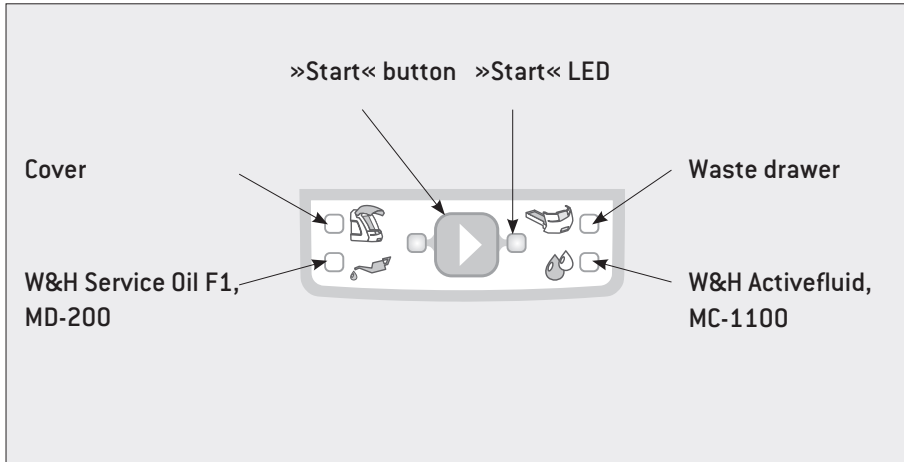



## Description – external cleaning ring for Assistina 3x3

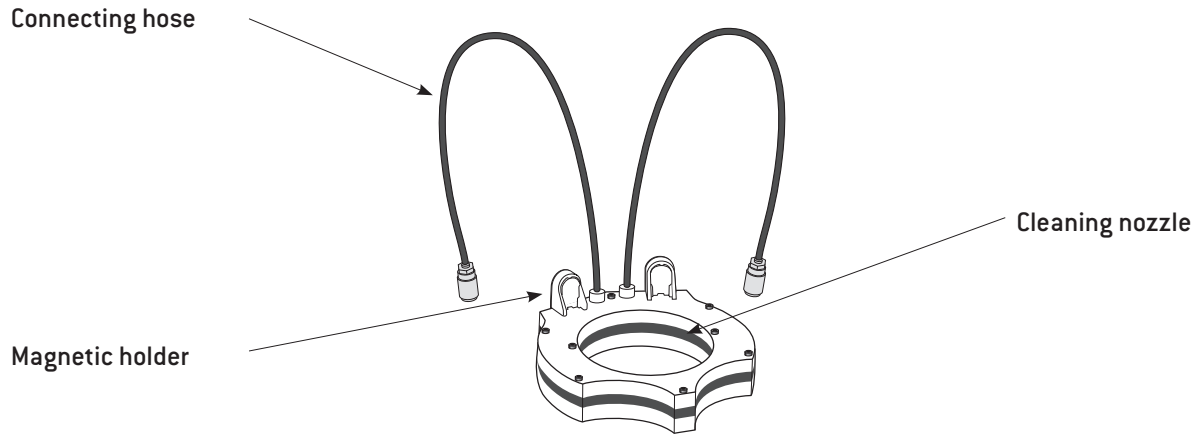

## Description – RM/ISO adaptors

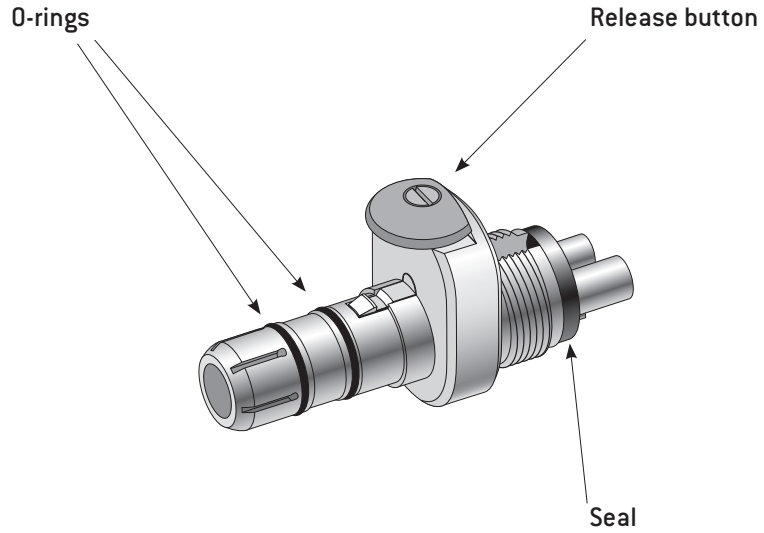

## Description – process chamber

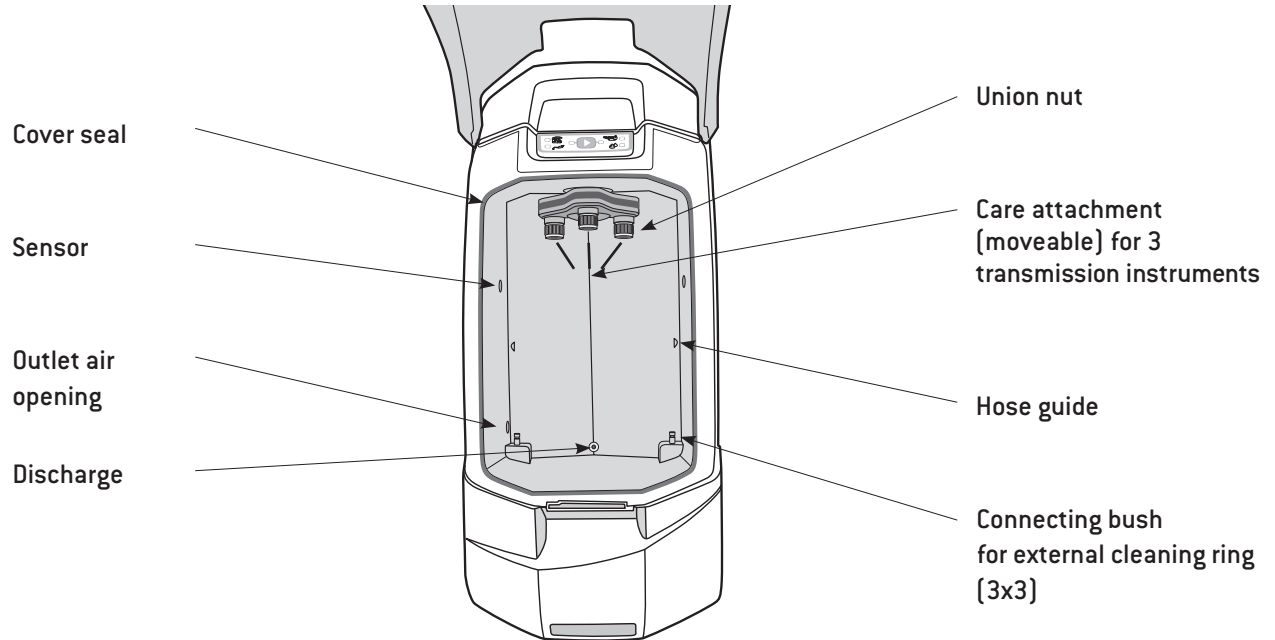

## Description – cartridge compartment

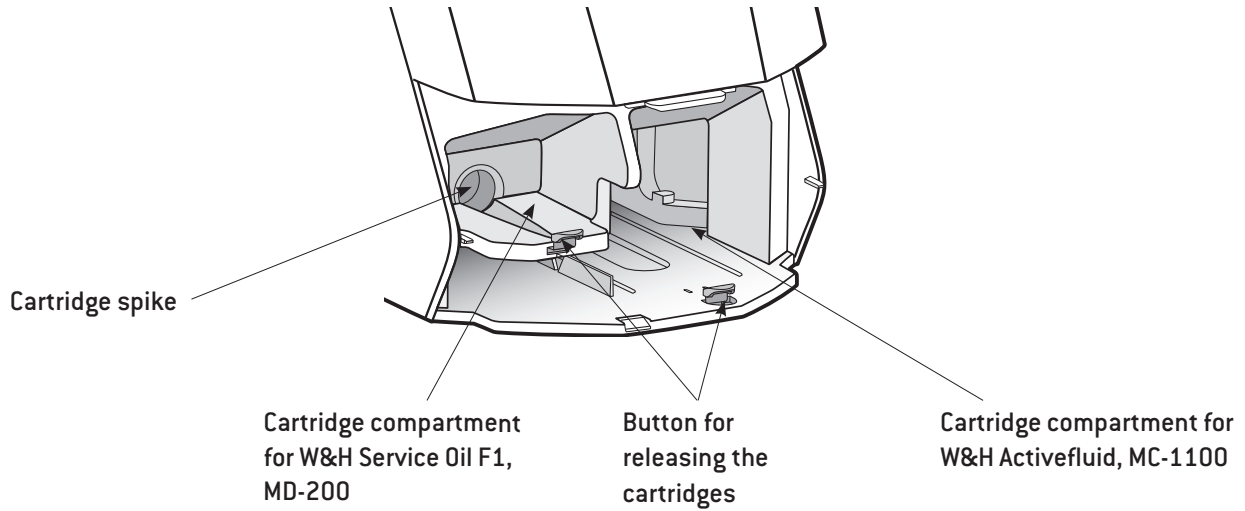

## Description – rear panel

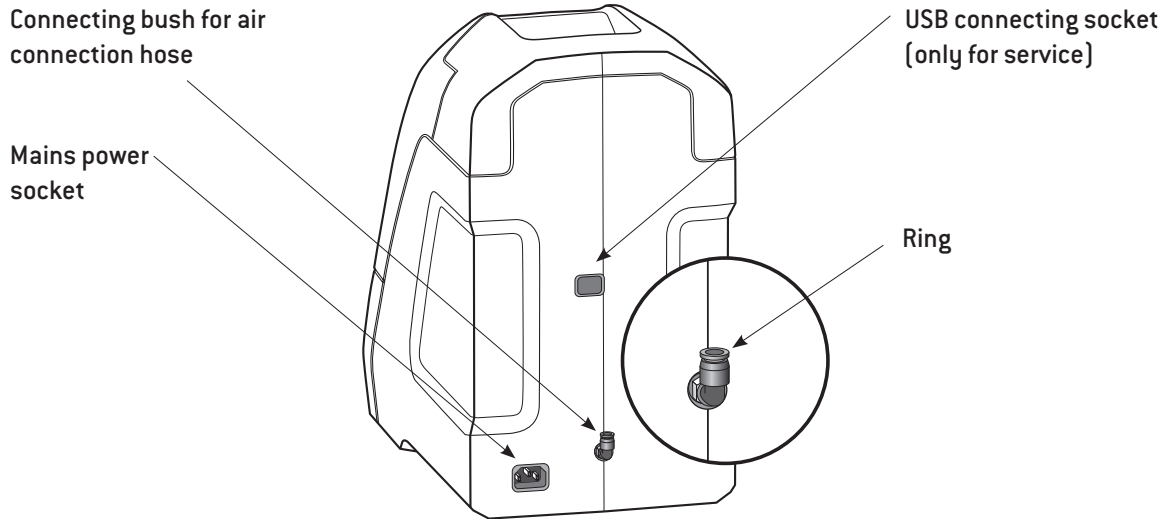

## 7. Start-up – insertion/removal of a cartridge



The cartridges must be at room temperature when they are inserted.



The cartridge spike is sharp.  
Be careful not to injure yourself on the projecting spike.

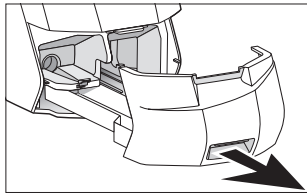

**1** Pull out the waste drawer.

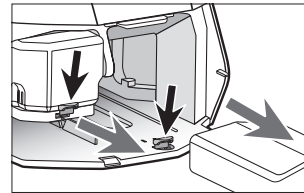

**3** Take out the cartridge.

- > Press the button for releasing the cartridge.
- > Pull out the cartridge.

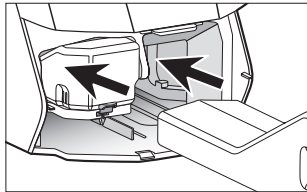

**2** Insert the cartridge.

- > Slide in the cartridge.
- > You should hear the cartridge engage.

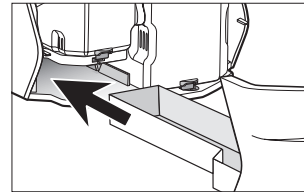

**4** Slide the waste drawer back in.



Whenever you replace the cartridge

- > always clean and disinfect the cartridge compartment,
- > carry out the initial filling.

Observe the manufacturer's instructions on use of the disinfectant.

## Start-up – insertion of the external cleaning ring (Assistina 3x3)

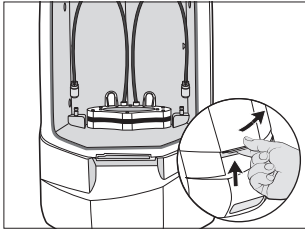

- ❶ Open the cover. Insert the external cleaning ring.  
The external magnetic ring is held in place magnetically.

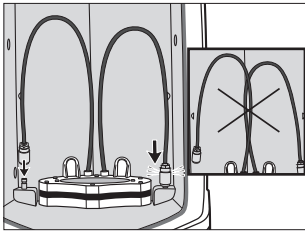

- ❷ Push the connecting hoses, keeping the hoses parallel onto the connection bushes.  
You should hear the connection hoses engage.

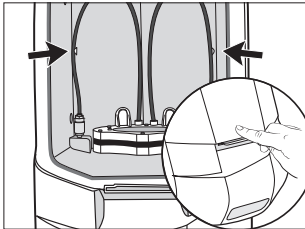

- ❸ Clamp the connection hoses into the hose guides.  
Close the cover.

## Start-up – removal of the external cleaning ring (Assistina 3x3)

 Remove the external cleaning ring from the Assistina unit before cleaning and disinfecting.

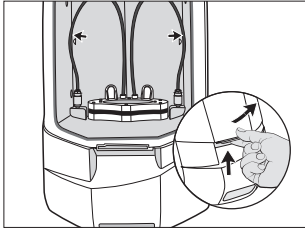

- 1 Open the cover.  
Take out the connecting hoses from the hose guides.

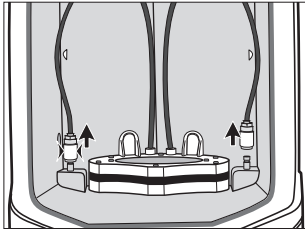

- 2 Disconnect the connecting hoses from the connecting bushes.

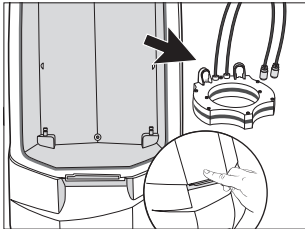

- 3 Remove the external cleaning ring.  
Close the cover.



## Start-up – establishing the air connection



Turn off the central air supply.  
Only use clean, filtered compressed air.

### Connecting the air connection hose

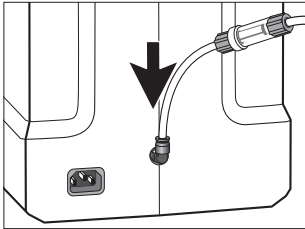

- 1 Central air supply is switched off.
- 2 Push on the air connection hose as far as it will go.

### Removing the air connection hose

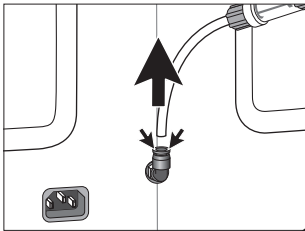

- 1 Turn off the central air supply.
- 2 Press the ring downwards. At the same time, pull out the air connection hose.

## Start-up – general



Always place Assistina on a flat level surface.

Make sure that it is easy to disconnect Assistina from the power supply.

### Connect the mains cable

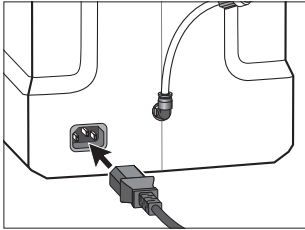

❶ Plug in the mains cable.



Pay attention to the positioning.

### Switch on / switch off the Assistina

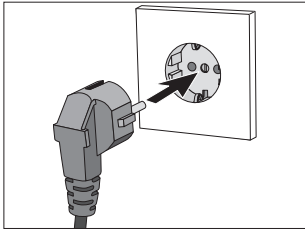

Switching ON

❶ Connect the device to the mains supply.

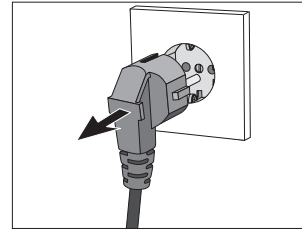

Switching OFF

❶ Unplug the device from the mains supply.



All of the LED light up orange for 1 second.  
The Assistina unit is ready for operation.

## Start-up – initial filling



Carry out the initial filling with the Assistina empty of transmission instruments.

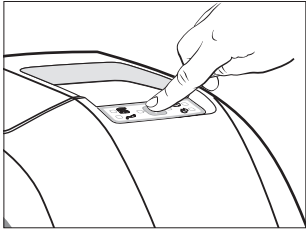

❶ Close the cover. Press the »Start« button for approx. 5 seconds.



The initial filling process for the Assistina unit will take approx. 2 minutes.

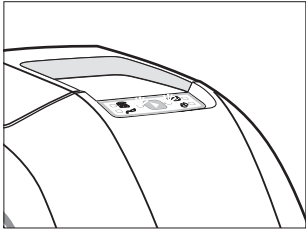

The »Start« LED light up green. The device is ready for use.



If the Assistina unit has been out of use for an extended period of time (approx. 14 days), repeat the initial filling process.

## Start-up – standby mode



If the unit is not operated for 15 minutes it switches to standby mode.  
The LED are not lit up.

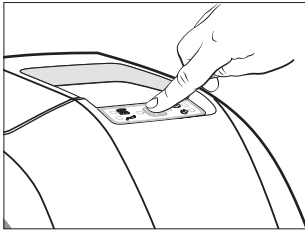

**Activating the Assistina unit**  
> Press the »Start« button.



All of the LED light up orange for 1 second.  
The Assistina unit is ready for operation again.

## Start-up – test run

---

- > Place a pre-disinfected transmission instrument onto the care attachment (see pages 33 – 35).
- > Start the Assistina unit (see page 36).



The transmission instrument will be slightly moist when you take it out.  
It then needs to be manually disinfected and sterilized (see page 31).

- > In the event of malfunctions (e.g. vibrations, unusual noises, overheating, failure or leakage), **switch off the Assistina unit immediately** and contact an authorized W&H service partner (see page 57).

## 8. Hygiene and maintenance – general information

---



> Follow your country-specific directives, standards and guidelines for cleaning, disinfection and sterilization.



> Wear protective clothing.

> Clean and disinfect the transmission instruments **immediately after each treatment**, in order to rinse out any liquid (e.g. blood, saliva etc.) that may have got inside and to prevent inside parts from seizing.

> Sterilize the transmission instruments after preparing them with the Assistina unit.

> Refer to the »Hygiene and care« instructions in the instructions for use of the transmission instruments.

**When using an Assistina 3x3 unit to prepare the transmission instruments:** follow the instructions in the chapters Pre-disinfection, Manual Disinfection, Sterilization and Storage.

**When using an Assistina 3x2 unit to prepare the transmission instruments:** follow the instructions in the chapters Pre-disinfection, Manual External Disinfection, Manual Disinfection, Sterilization and Storage.

> After having been prepared with the Assistina unit, the transmission instruments are prepared and ready for disinfection and sterilization.

> Make sure that the outside of the transmission instruments is completely dry prior to disinfection and sterilization.

# Hygiene and maintenance – process description



The preparation programme is fully automatic and takes around 6 min 30 sec (Assistina 3x3) or 6 min (Assistina 3x2) to complete when the unit is fully loaded.

**Assistina  
3x3**

**1** Pre-disinfection

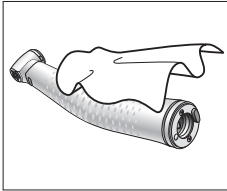

**2** Preparation with Assistina  
> External cleaning, internal cleaning,  
lubrication

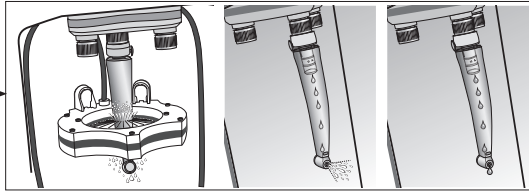

**3** If applicable  
manual  
disinfection

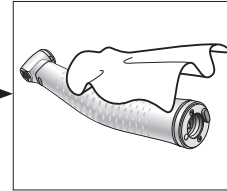

**4** Sterilization

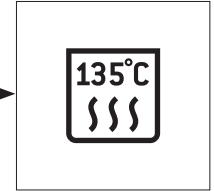

**Assistina  
3x2**

**1** Pre-disinfection

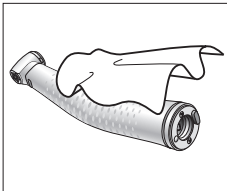

**2** Manual external  
cleaning

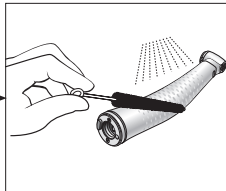

**3** Preparation with Assistina  
> Internal cleaning,  
lubrication

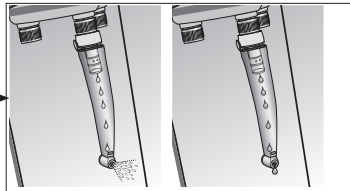

**4** If applicable  
manual  
disinfection

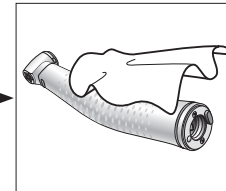

**5** Sterilization

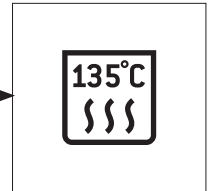

## Hygiene and maintenance – description of the adaptors

 During the preparation programme, the following adaptors can stay in the device without an instrument being inserted:



**06257600**  
Adapter RM/ISO

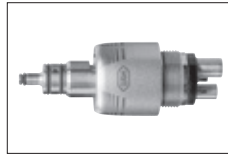

**02690400**  
Adaptor for all  
W&H products with  
the Roto Quick System

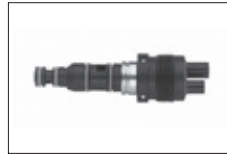

**04713200**  
Adaptor for KaVo  
Multiflex®\* connection

(\*Multiflex® is a registered  
trademark  
of KaVo GmbH, Germany)



**02083500**  
Borden 2/3-hole  
adaptor  
for turbines with a fixed  
connection

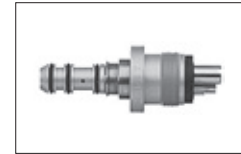

**02692000**  
Adaptor for Sirona  
turbines  
from the series T1, T2,  
T3

-  > Other adaptors and couplings must be removed from the device before the preparation programme.  
> Other adaptors see page 49.



# Hygiene and maintenance – connection/disconnection of the adaptors

 Damaged or leaking O-rings should be replaced immediately (see page 43).

## Connecting

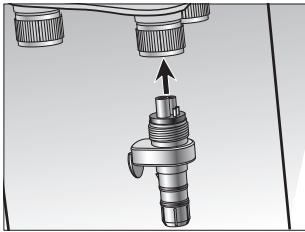

- 1 Open the cover. Push on the adaptor as far as it will go on the care attachment.

 Make sure that it is correctly positioned.

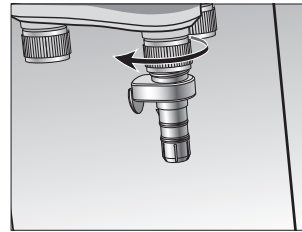

- 2 Firmly tighten the union nut anti-clockwise by hand (leak tightness).

## Removal

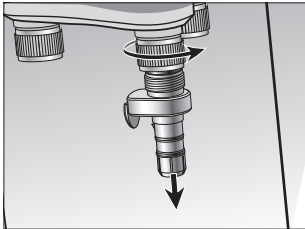

- 1 Unscrew the union nut by hand in a clockwise direction and remove it. Carefully pull the adaptor off the care attachment.

# Hygiene and maintenance – loading/removal

## Loading transmission instruments with ISO or Roto Quick connections

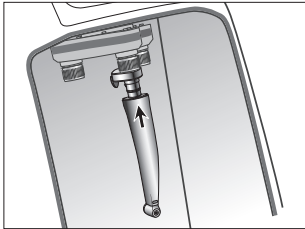

- 1 Open the cover. Push the transmission instrument with the outlet opening facing forwards onto the adaptor.



For air motors set the direction of rotation via the switching ring to clockwise or anti-clockwise.

It does not operate in the »0« position.

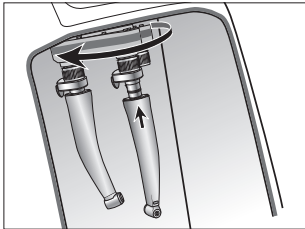

- 2 To load additional transmission handpieces, manually rotate the care attachment.

## Removal of transmission instruments with ISO or Roto Quick connections

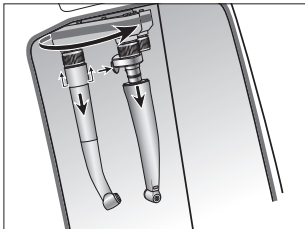

- 1 Open the cover. Carefully remove the transmission instrument.
  - > Press the release button on the RM/ISO adaptoror
  - > Slide the push-on sleeve of the Roto Quick adaptor upwards.

## Hygiene and maintenance – loading/removal



Transmission instruments with a fixed RM connection can be pushed straight onto the care attachment.

### Loading transmission instruments with a fixed RM connection

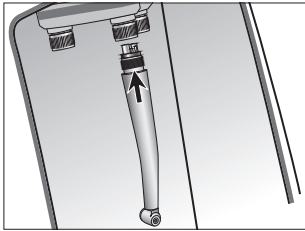

- 1 Open the cover.  
Push on the transmission instrument.

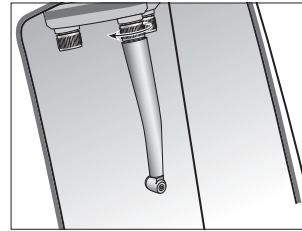

- 2 Firmly tighten the union nut anti-clockwise by hand [leak tightness].

### Removing transmission instruments with a fixed RM connection

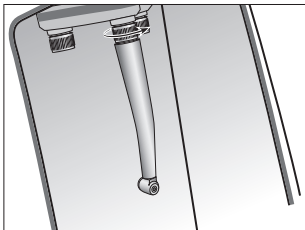

- 1 Open the cover. Unscrew the union nut by hand in a clockwise direction and remove it.

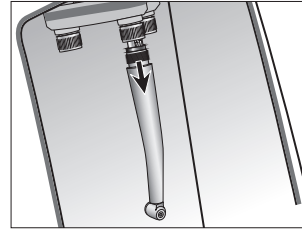

- 2 Pull off the transmission instrument.

## Hygiene and maintenance– preparation process (with time indication)

-  > The amount of W&H Activefluid, MC-1100 and W&H Service Oil F1, MD-200 used in the preparation process is carefully metered.
- > If fewer than 3 transmission instruments are loaded, the preparation process is shortened accordingly and the consumption of process fluids is correspondingly lower.

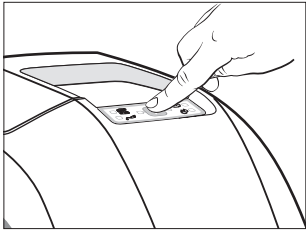

-  **1** Press the »Start« button. Both »Start« LED flash green.  
When the unit is fully loaded, the preparation programme takes
  - > approx. 6 min 30 sec (Assistina 3x3) or
  - > approx. 6 min (Assistina 3x2)and runs automatically.



- The preparation process is performed.
-  The time is shown in phases. After each previous phase, the LED is lit. During the phase, the LED flashes.



- The preparation process has finished correctly.
-  All LED light up green.

## 9. Cleaning and disinfection of the Assistina unit



W&H recommends cleaning the Assistina unit at least once daily or as required.

### Device

#### Preparation

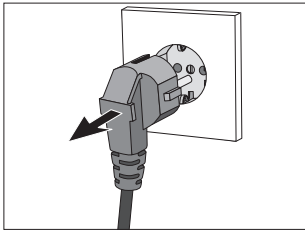

#### ❶ Switching OFF

Unplug the device from the mains supply.

#### Take off the cover

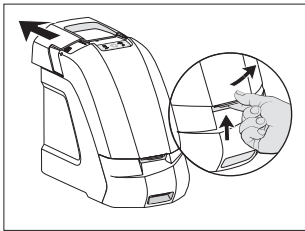

- ❶ > Carefully push the sliding lock backwards as far as it will go.
- > Open the cover.

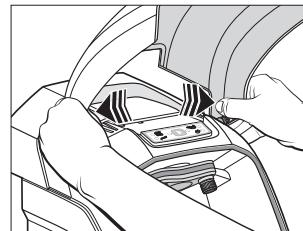

- ❷ Press the cover outward on both sides and remove.

# Cleaning and disinfection of the Assistina unit

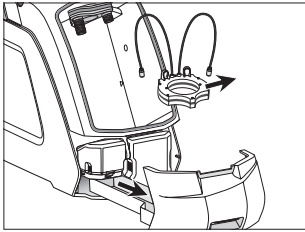

## ③ Assistina 3x3

- > Carefully pull out the waste drawer.
- > Dispose of the process fluid from the waste drawer in the appropriate way.
- > Remove the external cleaning ring.

## ③ Assistina 3x2

- > Carefully pull out the waste drawer.
- > Dispose of the process fluid from the waste drawer in the appropriate way.

## Device and adaptor

### Manual cleaning and disinfection, internal and external

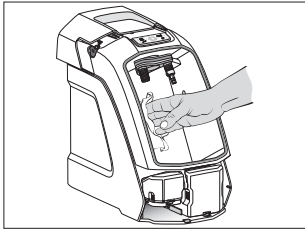

Clean the process chamber with a dry towel.

Wipe-disinfect the external surface and the process chamber.

- > Disinfection with disinfectants/wiping disinfection is recommended.
- > Only use disinfectants which have no protein-fixing effect.
- > Only use disinfectants which do not contain chlorine and which are certified by officially recognised institutes.
- > Observe the manufacturer's instructions on use of the disinfectant.

# Cleaning and disinfection of the Assistina unit

## Waste drawer, cover and external cleaning ring (Assistina 3x3)

### Manual cleaning and disinfection, internal and external

- > Rinse off the waste drawer, cover and external cleaning ring using demineralised water (< 38 °C) and clean the components with a brush.
- > Disinfection with disinfectants/wiping disinfection is recommended.
- > Only use disinfectants which have no protein-fixing effect.
- > Only use disinfectants which do not contain chlorine and which are certified by officially recognised institutes.
- > Observe the manufacturer's instructions on use of the disinfectant.

### Start-up after cleaning and disinfection

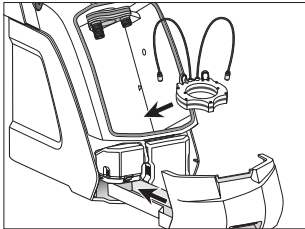

- 1 Insert the waste drawer and external cleaning ring (Assistina 3x3).

## Cleaning and disinfection of the Assistina unit

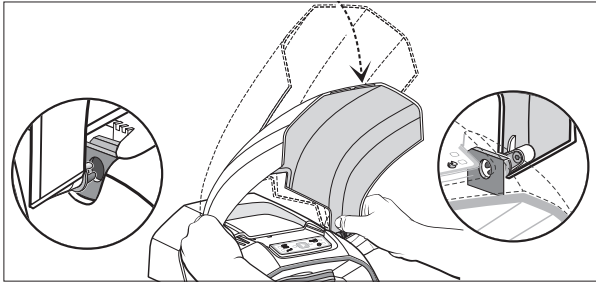

**2** Insert the cover.



Pay attention to the positioning!  
The cover audibly engages!

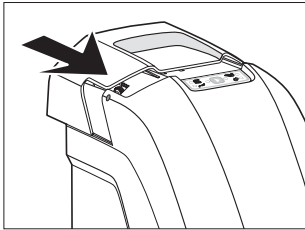

**3** Push the sliding lock forwards.

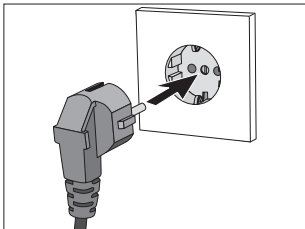

**4** Switching ON

Connect the device to the mains supply.



## 10. Maintenance – emptying the waste drawer

 Follow your country-specific directives, standards and guidelines in relation to the disposal of process fluids and to cleaning and disinfection.



 The »Start« LED and LED for the waste drawer light up orange.  
The illumination of the LED depends on the number of preparation processes. After emptying, it starts again.

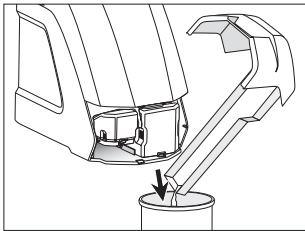

- 1 Carefully pull out the waste drawer.  
Dispose of the process fluid follow your country-specific guidelines in the appropriate manner.

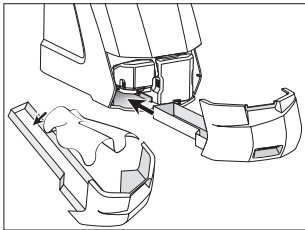

- 2 Clean, disinfect and re-insert the waste drawer.  
 Observe the manufacturer's instructions on use of the disinfectant.

## Maintenance – replacing O-rings

 Damaged or leaking O-rings should be replaced immediately.  
Do not use sharp tools!

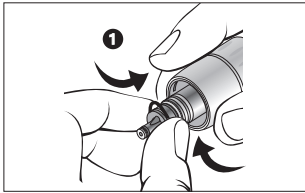

**1** Firmly squeeze the O-ring between your thumb and index finger so that it forms a loop.

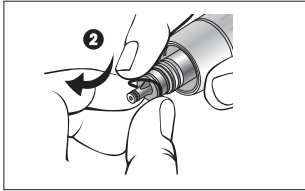

**2** Pull off the O-ring.

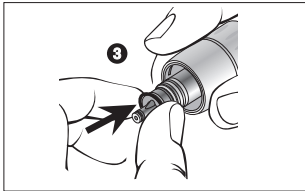

**3** Slide on a new O-ring.

# Maintenance – replacing the air filter



Switch off the central air supply before replacing the air filter.



- > Replace the air filter whenever it is dirty or at least 1x per year.
- > Only use clean, filtered compressed air.

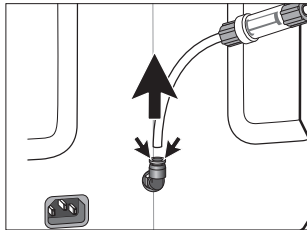

- 1** Press the ring downwards. At the same time, pull out the air connection hose.

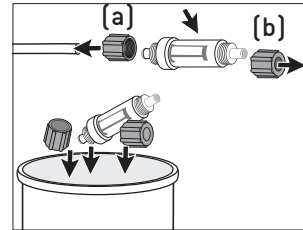

- 3** Replace the air filter and union nuts (a, b).

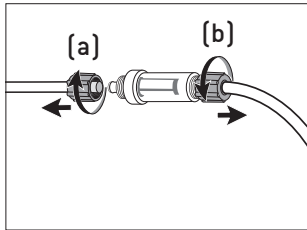

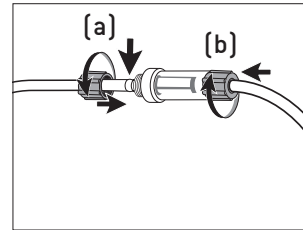

- 2** Open the union nuts (a, b) by screwing them anti-clockwise and pull them off.





- 4** Screw on the union nuts (a, b) by screwing them clockwise. Connect the air connection hose.



# 11. Error messages

LED display	Description	Remedy
 <p data-bbox="204 412 316 434">No LED lit up</p>	<p data-bbox="440 266 703 292">Device in standby mode</p>	<p data-bbox="944 266 1246 292">&gt; Press the »Start« button.</p>
 <p data-bbox="204 639 316 661">No LED lit up</p>	<p data-bbox="440 493 815 553">Device not connected to the mains supply.</p>	<p data-bbox="944 493 1246 519">&gt; Connect the power supply.</p>
 <p data-bbox="204 866 316 889">No LED lit up or <u>all</u> LED lit up orange</p>	<p data-bbox="440 721 671 747">Electronics defective.</p>	<p data-bbox="944 721 1509 780">&gt; Send the entire unit to an authorized W&amp;H service partner.</p>



## Error messages

LED display	Description	Remedy
 <p>»Start« LED flashes orange, LED for W&amp;H Service Oil F1, MD-200 lit up orange</p>	<p>W&amp;H Service Oil F1, MD-200 cartridge empty or not in the unit</p> <p>Electronics defective</p>	<ul style="list-style-type: none"> <li>&gt; Replace or insert the cartridge.</li> <li>&gt; Press the »Start« button once.</li> <li>&gt; Carry out the initial filling (see page 27): Press the »Start« button for approx. 5 seconds.</li>   <li>&gt; Send the entire unit to an authorized W&amp;H service partner.</li> </ul>
 <p>»Start« LED flashes orange, LED for W&amp;H Activefluid, MC-1100 lit up orange</p>	<p>W&amp;H Activefluid, MC-1100 cartridge empty or not in the unit</p> <p>Electronics defective</p>	<ul style="list-style-type: none"> <li>&gt; Replace or insert the cartridge.</li> <li>&gt; Press the »Start« button once.</li> <li>&gt; Carry out the initial filling (see page 27): Press the »Start« button for approx. 5 seconds.</li>   <li>&gt; Send the entire unit to an authorized W&amp;H service partner.</li> </ul>
 <p>»Start« LED flashes orange, LED for W&amp;H Activefluid, MC-1100 lit up orange</p>	<p>Air supply fails during the preparation process</p>	<ul style="list-style-type: none"> <li>&gt; Re-establish the main air supply.</li> <li>&gt; Press the »Start« button once.</li> <li>&gt; Carry out the initial filling (see page 27): Press the »Start« button for approx. 5 seconds.</li> </ul>



## Error messages

LED display	Description	Remedy
 <p data-bbox="151 412 368 460">»Start« LED lit up orange, cover lit up orange</p>	<p data-bbox="438 266 836 322">Cover opened during the preparation process</p>	<ul data-bbox="943 266 1453 348" style="list-style-type: none"> <li>&gt; Close the cover.</li> <li>&gt; Press the »Start« button 2x, the preparation process will then start.</li> </ul>
 <p data-bbox="151 641 368 689">»Start« LED lit up orange, waste drawer lit up orange</p>	<p data-bbox="438 507 628 533">Waste drawer full</p> <p data-bbox="438 596 831 622">Waste drawer open or not in the unit</p>	<ul data-bbox="943 507 1318 622" style="list-style-type: none"> <li>&gt; Empty the waste drawer.</li> <li>&gt; Press the »Start« button 1x.</li> <li>&gt; Close or insert the waste drawer.</li> </ul>
 <p data-bbox="151 882 368 930">»Start« LED lit up orange, waste drawer lit up orange</p>	<p data-bbox="438 736 788 792">Waste drawer opened during the preparation process</p>	<ul data-bbox="943 736 1453 818" style="list-style-type: none"> <li>&gt; Close the waste drawer.</li> <li>&gt; Press the »Start« button 2x, the preparation process will then start.</li> </ul>

## Error messages

LED display	Description	Remedy
 <p data-bbox="140 437 363 460">»Start« LED flashes orange</p>	<p data-bbox="437 264 839 320">Preparation process not correctly completed (e.g. due to power failure)</p>	<p data-bbox="941 264 1453 320">&gt; Press the »Start« button 2x, the preparation process will then start.</p>
 <p data-bbox="140 669 363 692">»Start« LED flashes orange</p>	<p data-bbox="437 505 815 561">»Start« button pressed during the preparation process</p>	<p data-bbox="941 505 1453 561">&gt; Press the »Start« button 2x, the preparation process will then start.</p>
 <p data-bbox="140 882 363 938">»Start« LED lit up orange, all other LED flash orange</p>	<p data-bbox="437 734 699 768">Sensor dirty or covered.</p>	<ul data-bbox="941 734 1501 880" style="list-style-type: none"> <li>&gt; Wipe-disinfect the sensor.</li> <li>&gt; Check position of hose external cleaning ring and clip in place if necessary.</li> <li>&gt; Press the »Start« button 2x, the preparation process will then start.</li> </ul>

## Error messages

LED display	Description	Remedy
 <p data-bbox="151 412 367 460">»Start« LED lit up orange, all other LED flash orange</p>	<p data-bbox="438 266 646 288">Sensor is defective</p>	<p data-bbox="944 266 1508 322">&gt; Send the entire unit to an authorized W&amp;H service partner.</p>
 <p data-bbox="175 639 335 661">All LED lit up orange</p>	<p data-bbox="438 493 630 516">Care attachment</p>	<p data-bbox="944 493 1388 516">&gt; Rotate the care attachment manually.</p>



If any of the described problems cannot be corrected by the remedy provided above, the unit will need to be inspected by an authorized W&H service partner (see page 57).

- > Disconnect the device from the power supply and air connection hose.
- > Remove the instruments from the device.



## 12. W&H Accessories



Use only original W&H accessoires/ spare parts or accessories approved by W&H.

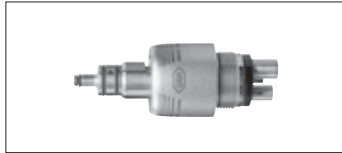

**02690400**

Adaptor for all  
W&H products with  
the Roto Quick System



**02083500**

Borden 2/3-hole adaptor  
for turbines with a fixed connection



**02679000**

Adaptor for detachable  
contra-angle handpiece heads

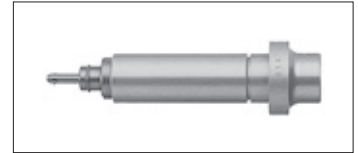

**02691000**

Adaptor for  
transmission instruments  
Sirona T1 CLASSIC



**02692000**

Adaptor for Sirona turbines  
from the series T1, T2, T3



**04713200**

Adaptor for KaVo  
Multiflex®\* connection



**05204600**

Adaptor for Entran  
contra-angle handpiece  
attachments

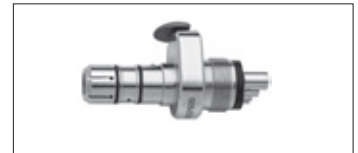

**06257600**

RM/ISO adaptor

(\*Multiflex® is a registered trademark  
of KaVo GmbH, Germany)

## W&H Accessories



**02675200**  
Air filter



**06691900**  
Cover (3x3)

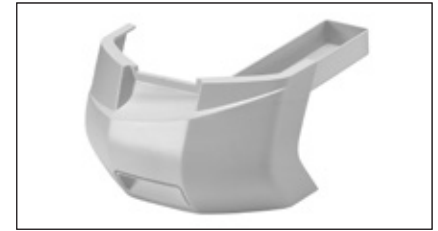

**06692500**  
Waste drawer



**06700100**  
Air connection hose (2 m)



**06692700**  
External cleaning ring

## W&H Accessories



**W&H Activefluid, MC-1100**

**06691600**

1 cartridge

**06872300**

1 carton (6 cartridges)



**W&H Service Oil F1, MD-200**

**06691500**

1 cartridge

**06872200**

1 carton (4 cartridges)

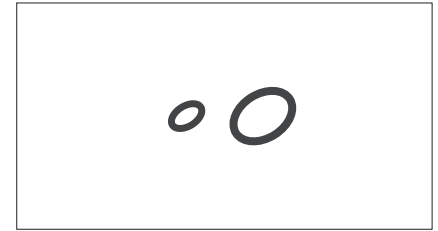

**02695700**

O-ring, adaptor RM/ISO

**02060100**

O-ring, adaptor Roto Quick, large

**02060200**

O-ring, adaptor Roto Quick, small

## 13. Servicing

---

### Repairs

If a defect occurs, always return all the equipment.

### Returns

- > Refer all questions to an authorized W&H service partner (see page 57).
- > Always return equipment in the original packaging.

## 14. Technical data

<b>Assistina</b>	<b>3x3</b>	<b>3x2</b>
Supply voltage:	100 – 240 V	
Permitted voltage fluctuation:	±10 %	
Nominal current:	0.1 – 0.3 A	
Frequency:	50 – 60 Hz	
Max. power consumption:	40 VA	
Air consumption:	approx. 100 NI/min.	approx. 60 NI/min.
Operating pressure:	5 – 10 bar (controlled via an integrated automatic pressure controller)	
Volume:	70 dB	65 dB
Dimensions in mm (WxDxH):	207 x 397 x 358 mm	
Weight:	7.5 kg	6.5 kg
Capacity:	1000 ml W&H Activefluid, MC-1100 200 ml W&H Service Oil F1, MD-200	

## Technical data

### Physical characteristics

Temperature for transport:	0 °C to +50 °C
Temperature for storage:	+5°C to +40 °C
Air humidity for storage and transport:	8 % to 80 % [relative], non-condensing
Ambient temperature during operation:	+10 °C to +40 °C
Air humidity during operation:	maximum relative humidity 80 % for temperatures up to 31 °C, decreasing linearly to 50 % relative humidity at 40 °C, non-condensing
Pollution level:	2
Overtoltage category:	II
Altitude:	up to 2000 m above sea level

# 15. Recycling and disposal

---

## Recycling

W&H considers that it has a special duty towards the environment. The Assistina unit along with its packaging has been designed to be as environmentally friendly as possible.



### **Disposal of Assistina units (main device and accessories)**

Follow your country-specific laws, directives, standards and guidelines for the disposal of used electrical devices.



Ensure that the parts are not contaminated on disposal.



### **Disposal of cartridges**

Follow your country-specific laws, guidelines, standards and directives for the disposal of cartridges for fluid. Ensure that



the parts are not contaminated on disposal.

## **Disposal of the packaging material**

All packaging materials have been selected according to environmentally compatible and disposal aspects and can be recycled. Please send old packaging materials to the relevant collection and reprocessing system. This way, you will contribute to the recycling of raw materials and the avoidance of waste.

# Explanation of warranty terms

This W&H product has been manufactured with great care by highly qualified specialists. A wide variety of tests and controls guarantee faultless operation. Please note that claims under warranty can only be validated when all the directions in the instructions for use have been followed

**As the manufacturer, W&H is liable for material or manufacturing defects within a warranty period of 12 months from the date of purchase.**

We accept no responsibility for damage caused by incorrect handling or by repairs carried out by third parties not authorized to do so by W&H.

Claims under warranty – accompanied by proof of purchase – must be sent to the vendor or to an authorized W&H service partner. The provision of service under warranty extends neither the warranty period nor any other guarantee period.

**12** months warranty



## Authorized W&H service partners

---

Find you nearest W&H service partner at <http://wh.com>

Simply go to the menu option »Service« for full details. Alternatively please contact:

**W&H (UK) LIMITED**, 6 Stroud Wood Business Centre, Park Street, St Albans, Herts AL2 2NJ, United Kingdom  
t + 44 1727 874990, f + 44 1727 874628, E-Mail: [technical.uk@wh.com](mailto:technical.uk@wh.com)

**W&H Impex Inc.**, 6490 Hawthorne Drive, Windsor, Ontario, N8T 1J9, Canada  
t + 1 800 2656277, + 1 519 9446739, f + 1 519 9746121, E-Mail: [service.ca@wh.com](mailto:service.ca@wh.com)

**W&H Impex Inc.**, 14300 Henn Rd., Dearborn, MI 48126, USA  
t + 1 800 2656277, + 1 519 9446739, f + 1 519 9746121, E-Mail: [service.us@wh.com](mailto:service.us@wh.com)

**W&H Austria GmbH**, Ignaz-Glaser-Straße 53, A-5111 Bürmoos  
t + 43 6274 6236-239, f + 43 6274 6236-890, E-Mail: [office.at@wh.com](mailto:office.at@wh.com)

**A-DEC AUSTRALIA CO. INC.**, Unit 8, 5-9 Ricketty Street, Mascot NWS 2020, Australia  
t + 61 2 83324000, f + 61 2 83324099, E-Mail: [a-dec@a-dec.com.au](mailto:a-dec@a-dec.com.au)

**Manufacturer**

**W&H Dentalwerk Bürmoos GmbH**  
**Ignaz-Glaser-Straße 53, 5111 Bürmoos, Austria**

**t + 43 6274 6236-0, f + 43 6274 6236-55**  
**office@wh.com    wh.com**

**Form Nr. 50733 AEN**  
**Version 006 / 01.12.2016**  
**Subject to alterations**

