

Short instructions for use

Primus 1058 Life



KaVo. Dental Excellence.

Distributed by:
KaVo Dental GmbH
Bismarckring 39
D-88400 Biberach
Phone +49 (0) 7351 56-0
Fax +49 (0) 7351 56-1488

Manufacturer:
Kaltenbach & Voigt GmbH
Bismarckring 39
D-88400 Biberach
www.kavo.com



Table of contents

1	Controls	4
1.1	Dentist element TM/C table	4
1.2	Dentist element S-table	5
1.3	Assistant element	5
1.4	Groups of keys	6
1.5	Foot control	8
2	Moving the patient chair	9
2.1	Positioning the dental chair manually	9
2.2	Positioning the patient chair with the foot control	9
2.3	Automatic positioning of patient chair	9
3	User menu	11
3.1	Starting and exiting from the user menu	11
3.2	Selecting and setting an option	12
4	Switching between levels and selecting a dentist	13
5	Setting the timer	15
5.1	Select the timer time	15
5.2	Set the timer time	15
6	Setting the handpieces	16
6.1	Adjusting functions	16
6.2	Turbine	18
6.3	INTRA LUX Motor KL 703 LED and COMFORTdrive	18
6.4	PiezoLED	18
6.5	Multifunctional handpiece	19
7	Using handpieces	20
8	Operation of the operating light KaVoLUX 540 LED (optional)	21
9	Using the CONEXIOcom (optional)	24
9.1	Using the patient communication menu with the foot control	25
10	Hygiene	27
10.1	Tumbler filling and bowl flushing	27
10.2	Rinsing program	27
10.3	Intensive germ reduction	29
10.4	Reprocessing the suction system including suction hoses	30
10.5	HYDROcean function	31
10.6	Replenishing Oxygenal	32
11	Warning messages	33
11.1	Safety shut-off	33
11.2	Additional warning messages	34
12	Service and error messages in the stand-by menu	35

1 Controls

CAUTION

These brief instructions for use only contain the essential operating functions.



It does not substitute for the Instructions for Use and Servicing that are part of the scope of delivery.

- ▶ The Instructions for Use and Servicing include all information and safety notes that must be observed to ensure intended use and safe operation of the product!
- ▶ The user must ensure that the unit works properly and is in satisfactory condition before each use.

1.1 Dentist element TM/C table

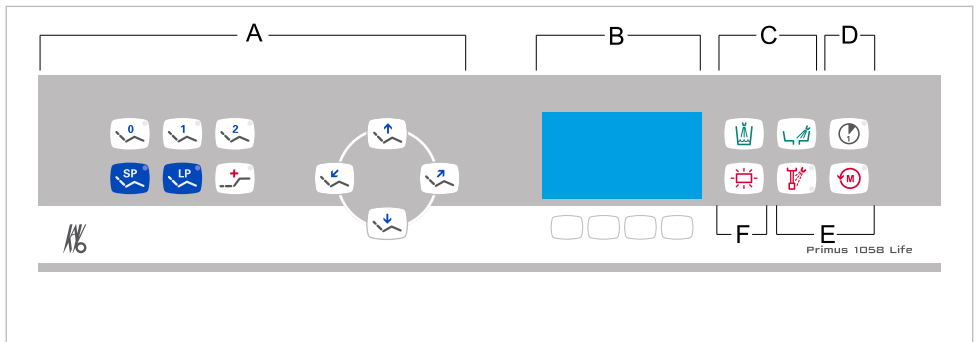

Dentist element TM/C table

- | | | | |
|---|------------------------------------|---|---|
| A | Group of keys for the dental chair | B | Group of keys for menu selection (MEMOspeed optional) |
| C | Group of keys for hygiene | D | Group of keys for the timer |
| E | Group of keys for the handpieces | F | Group of keys for illumination |

1.2 Dentist element S-table

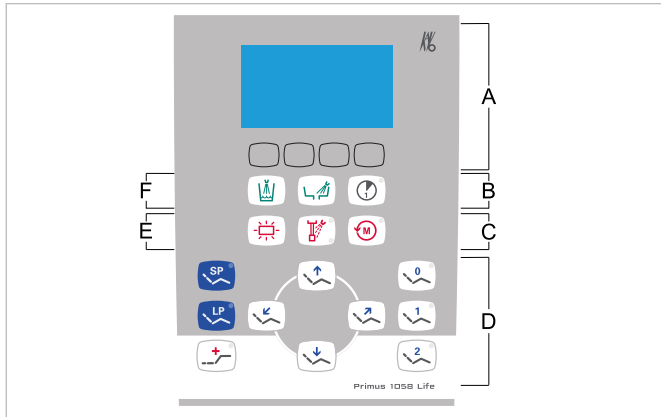

Dentist element S-table

- | | | | |
|---|---|---|------------------------------------|
| A | Group of keys for menu selection (MEMOSpeed optional) | B | Group of keys for the timer |
| C | Group of keys for the handpieces | D | Group of keys for the dental chair |
| E | Group of keys for illumination | F | Group of keys for hygiene |

1.3 Assistant element

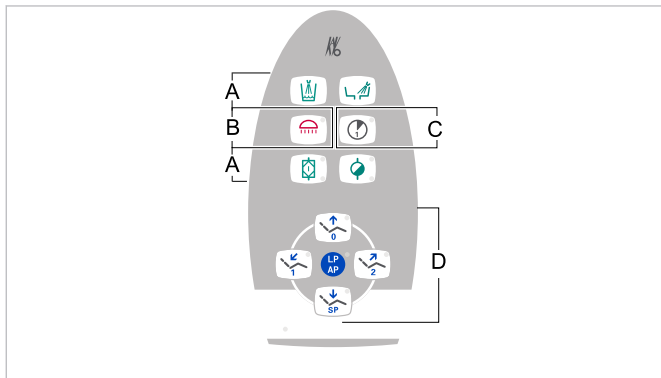

- | | | | |
|---|-----------------------------|---|------------------------------------|
| A | Group of keys for hygiene | B | Group of keys for illumination |
| C | Group of keys for the timer | D | Group of keys for the dental chair |



Note

Activate the KaVoLUX 540 LED operating light using the "Operating light" key on the assistant element. Only then the operating light can be operated by means of the sensor and the control panel of the operating light.

1.4 Groups of keys

Group of keys for the dental chair

The keys of the assistant unit each have two functions and show two symbols.



Assistant element key	Dentist element key	Name
		"Chair up" key
		"AP 0" key (automatic position 0)
		"Chair down" key
		"SP" key (rinsing position)
		"LP" key (last position)
		"AP" key (activate automatic position)
		"Backrest down" key
		"AP 1" key (automatic position 1)
		"Backrest up" key
		"AP 2" key (automatic position 2)
		"Collapsed position" key

Group of keys for illumination



Key	Name	Control element
	"Operating light" key	Assistant element
	"X-ray image viewer" key	Dentist element

Group of keys for hygiene

Key	Name	Control element
	"Tumbler filler" key	Dentist element and assistant element

Key	Name	Control element
	"Bowl rinsing" key	Dentist element and assistant element
	"Intensive germ reduction" key	Assistant element (optional)
	"HYDROclean" key	Assistant element

Group of keys for the handpieces/timer

Key	Name	Control element
	"Preselected spray" button	Dentist element
	"Direction of motor rotation" button	Dentist element
	"Timer" key	Dentist element and assistant element

Group of keys for the menu

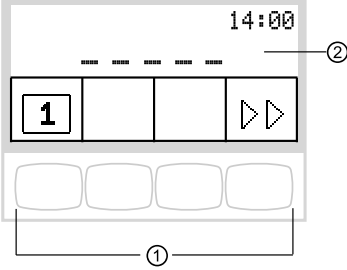
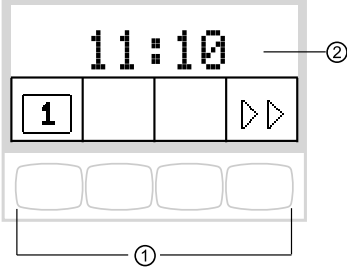
<p>Standby menu with MEMOSpeed</p> 	<p>Standby menu without MEMOSpeed</p> 
<p>① Menu function selection keys ② Display</p>	

1.5 Foot control

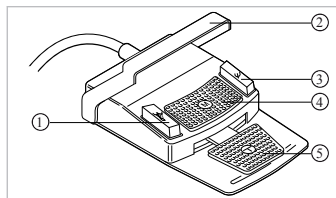

Item	Name	Function with handpiece mounted	Function with handpiece removed
①	"Spray pre-selection/AP" footswitch	Moves the dental chair into automatic position.	Sets the spray pre-selection.
②	U-shaped switch	Turns the safety shutoff On.	Switches the footswitches to the "Chair motion" function.
③	"Blown air/AP" footswitch	Moves the dental chair into automatic position.	Sets the preset blown air (chip blower).
④	Cross-switch: "Counterclockwise motor rotation"	Changes the position of the dental chair.	Selects the direction of motor rotation (for INTRA LUX motor KL 701/703 or COM-FORTdrive 200XD).
⑤	"Handpieces" foot-pedal	Generates a video/freeze frame if CONEXIOcom is installed.	Starts the motor and controls the speed/ intensity of the handpieces.

"Chair position" cross switch

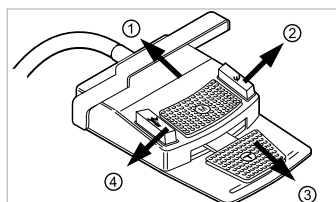

① Chair up

③ Chair down

② Backrest up

④ Backrest down

2 Moving the patient chair

2.1 Positioning the dental chair manually



Key Dentist element	Key Assistant element	Feature
		The chair moves up.
		The chair moves down.
		The backrest moves upward.
		The backrest moves downward.

2.2 Positioning the patient chair with the foot control

See also:

- "Chair position" cross-switch, Page 8
- 1.5 Foot control , Page 8

2.3 Automatic positioning of patient chair

Recalling automatic position through the dentist element

- ▶ Briefly press the desired button.
- ⇒ Chair automatically moves to the saved chair position.
- ⇒ When the saved chair position is reached, the LED on the button lights up.

Saving the automatic position through the dentist element

- ▶ Move the chair to the desired position.
- ▶ To save the chair position, press the "AP 0", "AP 1", "AP 2", "SP" or "Collapsed position" button until you hear a signal.
- ⇒ LED of the pressed button lights up. The chair position is saved.

Recalling an automatic position through the assistant element



- ▶ Briefly press the "AP" key.
- ⇒ The LEDs of the "AP 0", "AP 1", "AP 2", "SP", and "LP" keys flash for approximately four seconds.



- ▶ During these four seconds, briefly press the "AP 0", "AP 1", "AP 2", "SP" or "LP" key.
- ⇒ The chair moves into the selected automatic position.

Saving an automatic position through the assistant element

- ▶ Move the chair to the desired position.



- ▶ Briefly press the "AP" key.
- ⇒ The LEDs of the "AP 0", "AP 1", "AP 2", "SP", and "LP" keys flash for approximately four seconds.

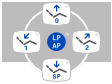

- ▶ During these four seconds, press the "AP 0", "AP 1", "AP 2" or "SP" button, until a beep is issued.
- ⇒ LED of the pressed button lights up. The chair position is saved.

Recalling an automatic position through the foot control

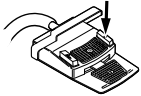

- ▶ Press the "SP" foot-operated button.

or



- ▶ Press the "LP" foot-operated button.
- ⇒ The chair moves into the selected automatic position.

Saving an automatic position with the foot control



- ▶ Hold down the foot pedal and foot-operated button "SP", and simultaneously press any button for an automatic position ("AP 0", "AP 1", "AP 2" or "SP") on the dentist or assistant unit until you hear a beep.
- ⇒ The automatic position is saved to the foot-operated button.

or

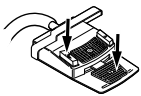

- ▶ Hold down the foot pedal and foot-operated button "LP", and simultaneously press any button for an automatic position ("AP 0", "AP 1", "AP 2" or "SP") on the dentist or assistant unit until you hear a beep.
- ⇒ The automatic position is saved to the foot-operated button.

3 User menu

The following options can be opened in the user menu:

Option	Feature	Description
1	Firmware	Display current firmware version.
2	Time of day	Set time of day.
3	Date	Set date.
4	Time display mode	Setting the time of day display mode: <ul style="list-style-type: none"> • Time of day only • Time of day without seconds
5	Language	Set menu language: <ul style="list-style-type: none"> • Deutsch • English • Italiano • Français
6	LCD	Set contrast of LCD display.
7	Licenses	Display of activated licenses

3.1 Starting and exiting from the user menu

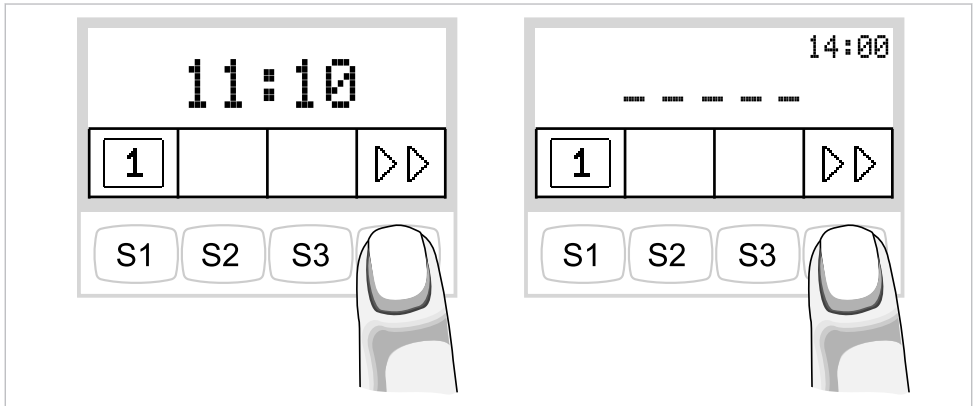

▶ Press the "Next" key (S4) to switch to the user menu.

⇒ Displays option 1 "Firmware".





▶ Press the "Save" key (S1) to exit from the user menu.

⇒ The changed settings are saved.

3.2 Selecting and setting an option

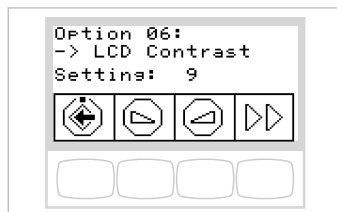

▶ Press the "Decrease value" or the "Increase value" keys to select the desired parameter or value.

See also:

 Instructions for use Primus 1058 Life

4 Switching between levels and selecting a dentist

Standby menu

The unit starts in the standby menu.

Available with MEMOSpeed licence only:

The device automatically switches to its standby menu when you close the handpiece menu and the patient communication menu.

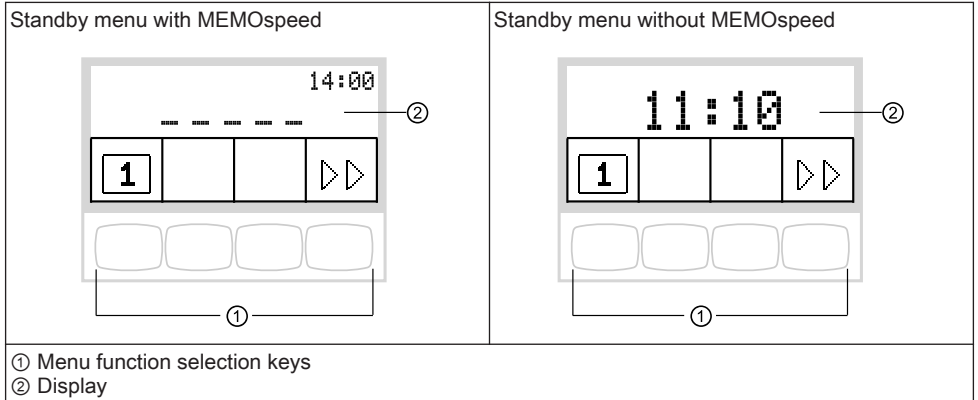

Switching between levels

Available with MEMOSpeed licence only:

Level switching is deactivated in the basic state.

The level switching symbol displays the current dentist.

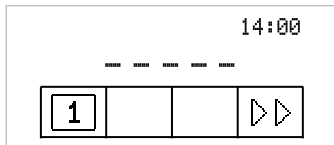

Note

The device acts like on level E when level switching is deactivated.



- To switch between levels, keep the "Direction of motor rotation" and the "Bowl flushing" keys and the foot pedal depressed, until a beep can be heard.

After activating level switching, the level switching symbol shows the level (E, 1 2 or 3 - level E is selected in the example shown). The pre-selected dentist is only displayed very small in the level switching symbol.

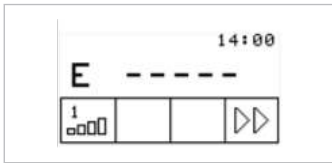
**Note**

The device automatically saves the activation of level switching for the current dentist.

**Note**

Level switching is deactivated using the same key combination as activation.



- ▶ Briefly press "Preselect level" key to select the level.

Selection of dentist

- ▶ Level switching blocked: press "Dentist" key to select dentist 1 or dentist 2.

or



- ▶ Level switching permitted: press "Preselect level" key long to select dentist 1 or dentist 2.

5 Setting the timer

5.1 Select the timer time



- ▶ Press the "Timer" key briefly to start or stop the timer.
- ⇒ LED flashes while the timer counts down.

The elapsed time is shown in the display on the top right.

A beep is issued after the timer time is elapsed.

5.2 Set the timer time

A maximum 59:59 minutes can be set using the timer.

Requirement

Standby menu is selected.



- ▶ To set a timer time (e.g. Timer 1), press the "Timer" key until you hear a beep.

⇒ The display switches to the settings menu for the timer time.

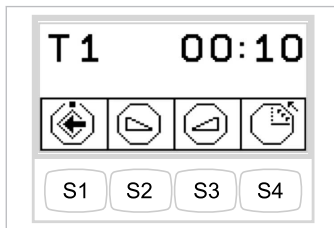

- ▶ Press the "Decrease value" key to reduce the time.

or



- ▶ Press the "Increase value" key to increase the time.
- ⇒ The set time is shown on the display.

Symbol	Function
	The timer counts down (for example: 0:30 to 0)
	The timer counts up (for example: 0 to 0:30)



- ▶ Press the "Save" button to save the value.
- ⇒ A beep confirms that the value has been saved.



or

- ▶ Press the "Back" button to return to the default (without saving).

6 Setting the handpieces

6.1 Adjusting functions

Switch to the settings menu of the active element

Level switching must be activated for the selection of a level.

See also:

-  4 Switching between levels and selecting a dentist, Page 13



- ▶ Remove the handpiece from the holder.
- ▶ Briefly press "Preselect level" key to select the level.



- ▶ Press "Preselect level" button for 4 seconds in order to change settings.
- ⇒ The display switches to the Settings menu of the selected handpiece. (Available only with MEMOSpeed licence with activated level switching in level 1-3)

Saving the values



- ▶ Press the "Save" key to save the values. You can save after setting each value, or after setting all values.
- ⇒ Saving is acknowledged by a beep.
- ⇒ This closes the "Settings" menu.

Set the speed/power intensity (in levels 1 to 3 only)



- ▶ Press the "Decrease value" key to decrease the speed.

or



- ▶ Press the "Increase value" key to increase the speed.
- ⇒ The speed is shown in the display.

Set the power intensity (in levels 1 to 3 only)



- ▶ Press the "Decrease value" key to decrease the speed/power intensity.

or



- ▶ Press the "Increase value" key to increase the speed/power intensity.
- ⇒ The speed/power intensity is shown on the display.

Setting the minimum and maximum speed

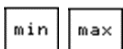

- ▶ Press the "min/max" (S4) keyed to toggle between the settings menus for minimal and maximal speed.



Setting the cooling level

Requirement

Settings menu for turbine is selected.



- ▶ Press the "Preselected spray" button.

Key	Feature
	No LED is on: No cooling
	One LED is on: Spray air cooling status
	Both LEDs are on: Spray cooling status

Setting the direction of motor rotation



Note



The direction of motor rotation can only be changed when the motor is at rest.

Requirement

Settings menu for motor is selected.





- ▶ Press the "Direction of motor rotation" key.

Icon	Feature
	Clockwise rotation
	CCW rotation The LED is on when CCW motor rotation is set.

Setting the water/air heating (only with the multifunctional handpiece)

- ▶ Adjust the heating with the key for "Air/water heating".

Symbol	Function
	Air/water heating "on"
	Air/water heating "off"

Define operating mode (PiezoLED only)



Note

The selection of the mode depends on the treatment method and the tip used. For information about the selection of an operating mode, please refer to the "Operating modes P1 / P2 / P3 and E" section of the "PiezoLED Instructions for Use".

P1

- ▶ Press the "Mode" (S4) key for 4 seconds to select the operating mode.

⇒ Modes P1 / P2 / P3 / E are available for selection.

Symbol	Feature
P1	Mode P1
E	Mode E

6.2 Turbine

The following settings can be changed:

- Speed
- Cooling status

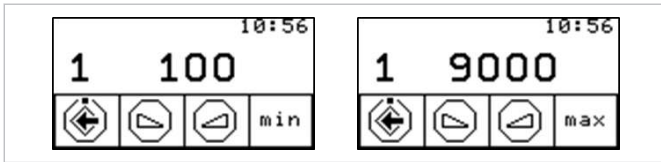

Settings menu for minimal/maximal speed

6.3 INTRA LUX Motor KL 703 LED and COMFORTdrive

The following settings can be changed:

- Direction of motor rotation
- Speed
- Cooling status

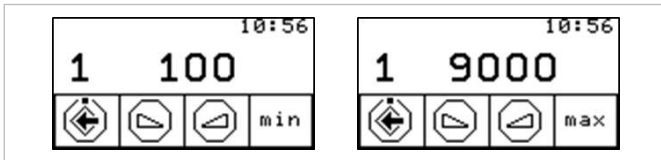

Settings menu for minimal/maximal speed

6.4 PiezoLED



Note

Please comply with the enclosed "PiezoLED" Instructions for Use.

The following settings can be changed:

- Output intensity
- Operating mode (P1 / P2 / P3 / E)
- Cooling status (no cooling / spray water cooling)

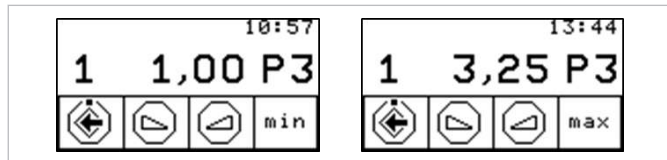

Settings menu for minimal/maximal intensity

6.5 Multifunctional handpiece

The following settings can be changed:

- Air/water heating

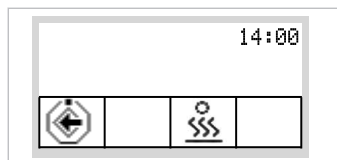

Settings menu for multifunctional handpiece

7 Using handpieces

- ▶ Take the handpiece (e.g., turbine, motor, PiezoLED, etc.) from the holder.
- ⇨ The handpiece is active.



- ▶ Press the foot pedal.
- ⇨ The removed handpiece runs at the set speed or intensity.



- ▶ Changing speed or intensity with the foot pedal.
- ⇨ The left stop corresponds to the minimum speed/intensity.
- ⇨ The right stop corresponds to the maximum speed/intensity.

Preselect counterclockwise motor rotation

- ▶ Take motor off the holder.
- ⇨ The handpiece is active.

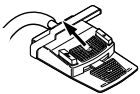

- ▶ Slide the cross switch upward.
- ⇨ The direction of motor rotation is reversed each time the cross-switch is actuated: counterclockwise rotation - clockwise rotation.
- ⇨ The direction of motor rotation is displayed on the dentist element.

Setting the instrument light

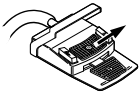

- ▶ Slide the cross switch to the right. (spotlight function)
- ⇨ Cold light "On".

8 Operation of the operating light KaVoLUX 540 LED (optional)

The KaVoLUX 540 LED operating light can be used in the following modes:

- Normal light: preset at 5,500 Kelvin and 30,000 Lux corresponding to daylight quality
- COMPOsave-Modus: enables longer processing periods for composites by filtering the blue components of the light
- Dimmed light: approx. 4,000 Kelvin; equivalent to the light of a halogen operating lamp
- Laser mode: Light mode, which has no negative influence on the KaVo KEY Laser III, the KEY Laser 3+ or the KaVo DIAGNOdent.

Turning the operating light On and Off



Note

Activate the KaVoLUX 540 LED operating light using the "Operating light" key on the assistant element. Only then the operating light can be operated by means of the sensor and the control panel of the operating light.

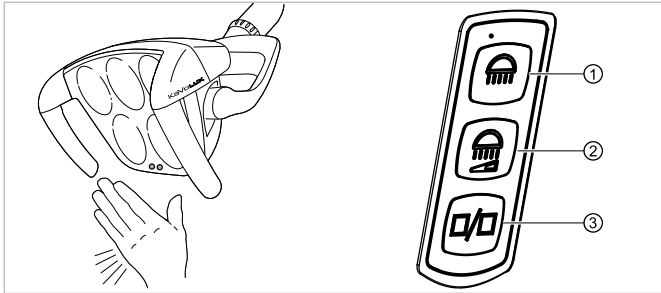

Sensor / control panel KaVoLUX 540 LED T

- ① "Operating light" key
- ② "Operating light dimming" key
- ③ "Mode/ colour temperature" button



- ▶ Press the "Treatment light" button.

or

- ▶ Hold your hand just in front of the sensor.
- ⇒ Treatment light is switched on, Display LED shining.



- ▶ Press the "operating light" button once again.

or

- ▶ Hold your hand just in front of the sensor.
- ⇒ Treatment light is switched off, Display LED not shining.

Setting the brightness



- ▶ Press and hold down the "Treatment light" key.
- ⇒ Signal buzzes, brightness changes from dark to bright in stages.
- ▶ When the desired brightness is reached, release the "Treatment light" key.

Switch on COMPOsave mode



- ▶ Press the "Dim treatment light" key.

or

- ▶ Hold your hand in front of the sensor for 2 sec.
 - ⇒ The COMPOsave mode switches on.
 - ⇒ The COMPOsave mode can be recognised by the yellow light.



- ▶ Press the "Dim treatment light" key.

or

- ▶ Hold your hand in front of the sensor for 2 sec.
 - ⇒ The treatment light switches back to normal light mode.

Setting the brightness of the dimmer (COMPOsave mode or normal light)



- ▶ Press and hold down the "operating light dimming" button.
 - ⇒ Signal buzzes, brightness changes from dark to bright in stages.
- ▶ Once the desired brightness is reached, release the "operating light dimming" button.

Switching between COMPOsave mode and dimmed light and normal light



- ▶ Press the "Mode/colour temperature" button
 - ⇒ The treatment light switches from COMPOsave mode to dimmed normal light.
- ▶ Press the "Mode/colour temperature" button once again.
 - ⇒ The treatment light switches back to COMPOsave mode.
 - ⇒ The COMPOsave mode can be recognised by the yellow light.

Setting the colour temperature



- ▶ Press and hold down the "Mode/colour temperature" button
 - ⇒ Colour temperature changes in five steps.
- ▶ Release the button when the desired colour temperature is achieved.

Turning the laser mode On and Off



- ▶ Press the „operating light“ button and the "operating light dimming" button on the operating light simultaneously.
 - ⇒ The laser mode switches on.
 - ⇒ Laser mode is activated: the operating light shines for 1 second in green and then changes to a white light.

or

- ▶ Hold your hand in front of the sensor for 3 sec.
 - ⇒ The laser mode switches on.
 - ⇒ Laser mode is activated: the operating light switches initially in COMPOsave mode and then shines for 1 second in green and then changes to a white light.

Operation of the 3D joint

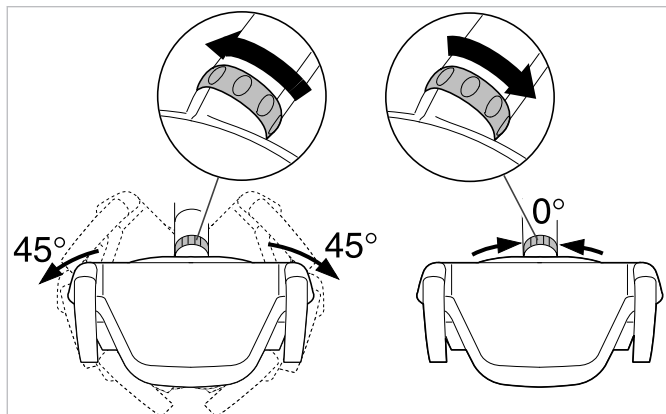

- ▶ Turn the switching ring to the left until it snaps into place.
 - ⇒ Treatment light can be rotated 45° to the left or 45° to the right.
- ▶ Turn the switching ring to the right and it will spring back to its original position.
- ⇔ If the treatment light is turned to the centre position (zero position), it will automatically lock into place in the centre position.

9 Using the CONEXIOcom (optional)



Note

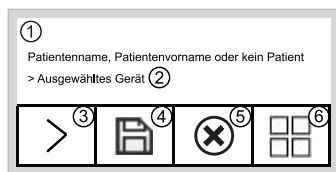

For all CONEXIOcom functions, the dental unit must be connected to an installation of the KaVo "CONEXIO" software.

The function of the CONEXIOcom menu is to control the display of previously recorded and saved images and videos. In order to use the function, the unit must have access to the data of the KaVo Software "CONEXIO" software. For details on the configuration, please refer to the "CONEXIO" installation instructions.



Display CONEXIOcom

No	Icon	Setting
1	-	Info line This line displays the active patient name (if selected in CONEXIO) under which the data obtained are stored. If no patient is selected, images and videos are stored in the clipboard under "unassigned patient".
2	-	If a device is active, the device type is shown. The following is implemented at this time: DIAGNOcam U ERGOcam One
3		Next image/video To be able to communicate efficiently with the patient, individual images can be selected and displayed directly. This uses a rolling system that advances from left to right and from top to bottom.
4		Save image/video Press briefly - saves the selected image/video. Press long - all images/videos are saved in the swap tray. If no patient is selected, the images stay in the clipboard and cannot be saved permanently. As soon as a patient is selected, these temporary data in the clipboard are deleted. When an active patient is logged off (or a new patient is logged on) in CONEXIO, a query is shown asking whether the images in the shall be deleted or saved. Data deleted at this point cannot be restored subsequently.
5		Discard image/video Press briefly - deletes the selected image/video Press long - all images/videos in the clipboard are deleted
6	 	Screen display: This button changes the display on the monitor. The following settings can be made: 1/2/4/6 – number of images displayed. The live image is always shown as the last image in split view.

No	Icon	Setting
		
		

- ▶ To activate a function, press the key below the info line briefly or long.

Starting and exiting the patient communication menu

- ▶ Make sure that the treatment unit has access to the KaVo CONEXIO software.
 - ⇒ As soon as an imaging device is activated, the patient communication menu opens automatically.
- ▶ Select the right patient on the corresponding PC.
 - ⇒ The display switches to the patient communication menu.
 - ⇒ If no patient was selected, images from the clipboard are displayed.
 - ⇒ When the patient is logged off the corresponding PC, the clipboard is deleted.

9.1 Using the patient communication menu with the foot control

The patient communication menu can also be controlled with the foot control.

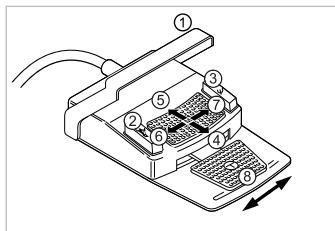

Item	Name	Feature
①	U-shaped switch	Delete image/video: <ul style="list-style-type: none"> • Press briefly: Deletes the selected image/video ▪ Press long: All images/videos in the clipboard are deleted
②	Cross key "up"	Split View: <ul style="list-style-type: none"> ▪ Show several images
③	Cross key "down"	Split View: <ul style="list-style-type: none"> ▪ Show fewer images
④	Cross key "left"	Switching between the modes: <ul style="list-style-type: none"> • Picture ▪ Video
⑤	Cross key "right"	Switches screen display between full-screen and normal view
⑥	"SP" foot-operated button	Select next image/video

Item	Name	Feature
⑦	"LP" foot-operated button	Select previous image/video
⑧	Foot pedal	Save image/video: <ul style="list-style-type: none"> • Press briefly: Saves the image/video ▪ Press long: All images/videos are saved in the clipboard.

Note

If no patient is selected, the images stay in the "Swap Tray" and are not saved permanently. As soon as a patient is selected, these temporary data in the "Swap Drying" are deleted. When an active patient is locked off for a new patient is logged on in the "CONEXIO" software, a query is shown asking whether the images in the "Swap Tray" shall be deleted or saved. If the data is deleted, it cannot be restored subsequently.

10 Hygiene

10.1 Tumbler filling and bowl flushing

The following settings can be changed:

- Tumbler filling time
- Bowl rinsing time



- ▶ Press the "Tumbler filler" button briefly to start filling the tumbler.



or

- ▶ Press the "Bowl flush" key briefly to start the bowl flush.

- ▶ Press the "Set hygiene function" button for more than 4 seconds to start the programming mode. Set the period of time in 200 ms increments. Minimum: 0.4 s. An acoustic signal is heard every second.
- ▶ Release the button to save the selected value.

10.2 Rinsing program



- ▶ Briefly press the "Intensive germ reduction" button.

Preparation

- ▶ Position the germ reduction attachment on the porcelain spittoon bowl.

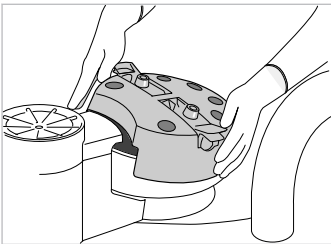

- ▶ Place the dental instruments on the germ reduction attachment.

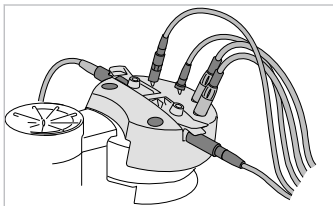

The cannula of the triple-function and multifunctional handpieces must be removed for the rinsing program and the intensive germ reduction.

S-table

- ▶ Lock the swing-arm into the front catching position to ensure that the handpiece is removed.
- ▶ In the case of swing-arms without a catching function, insert the swing-arm lock (**Mat. no. 1.008.1511**) to ensure that the handpiece is removed.

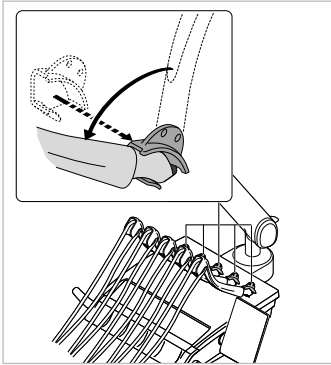

- ▶ Hold the 3-way or multifunctional handpiece at the gripping sleeve and take off the cannula with a slight twisting motion.

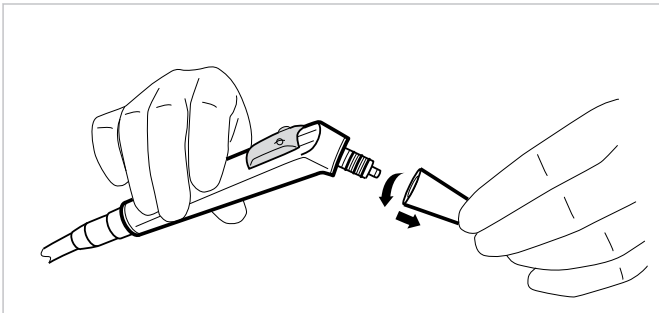

- ▶ Insert the triple-function or multifunctional handpieces without the cannula into the clamping device of the germ reduction attachment. Make sure that the "W" button (water) of the triple-function or multifunctional handpiece is activated, and that no air is exiting.
- ▶ Place the instrument hoses of the dentist and assistant elements in the corresponding places of the germ reduction attachment.
- ▶ Support tubing with the enclosed holder.



Note

All water regulation mechanisms for the motor, instruments, and multiflex couplings must be open.

Set rinsing time



- ▶ Press the "decrease value" or "increase value" keys to select rinsing program 01 "Programm vorbereiten: 01" or rinsing program 02 "Programm vorbereiten: 02".
- ⇒ The standard value for rinsing program 01 is 00:20 minutes per instrument.
- ⇒ The standard value for rinsing program 02 is 2:00 minutes per instrument.



- ▶ Press the foot pedal to display the time for rinsing the instrument hoses and the three-function or multifunctional handpiece.



With the foot pedal of the foot control being pressed down, the rinsing time for the respective rinsing programme can be set in the range from 00:01 to 4:00 minutes using the "Decrease value" and "Increase value" buttons.

The rinse program proceeds in four steps. For rinse program 01, the cycle starts in step 2, and for rinse program 02, the cycle starts in step 4.

Start rinsing programme



- ▶ Briefly press the "Intensive germ reduction" button.

Discontinue the rinsing programme



The rinsing programme can be stopped at any time by pressing the "intensive germ reduction" key.
If the device is turned off and then on again, the rinsing program also stops.

10.3 Intensive germ reduction



An additional intensive germ reduction must be carried out during extended downtimes (> 4 weeks).
The need for intensive disinfection is automatically displayed in the top LED of the "Intensive germ reduction" button at first start-up and after downtimes (weekend, holidays, vacation, etc.).
If an audible signal is issued every 10 seconds and the bottom LED of the "Intensive germ reduction" button flashes, the KaVo OXYGENAL 6 must be replenished. If a beep is issued during the filling process (10 times at a one-second interval), the container is full.



Note

If the amalgam separator malfunctions during intensive germ reduction, the entire process is stopped. The bottom LED of the "HYDROclean" button flashes.



- ▶ Press the "Intensive germ reduction" button for more than 4 seconds until you hear an acoustic signal and the upper LED of the "intensive germ reduction" button flashes. The display switches to the intensive germ reduction menu.

- ▶ Perform the preparations for intensive germ reduction.

See also:

- 📖 10.2 Rinsing programme, Page 27



- ▶ Press the "Intensive germ reduction" button.
- ⇒ Intensive germ reduction starts and runs through several steps. The process can be followed on the display.

Intensive germ reduction is completed when "01 intensive germ reduction completed" appears on the display.

- ▶ Put all handpieces in holders and take off the germ reduction attachment.

Interrupt intensive germ reduction during the dwell time

So that no one will have to remain with the device throughout the entire intensive germ reduction process, intensive germ reduction can be interrupted in program step 4 (e.g. on the last workday before the weekend). Program step 4 is the dwell time, in which the microorganisms are killed by an increased OXYGENAL 6 concentration.

Requirement

intensive germ reduction is in program step 4.
You hear a beep for 4 seconds.

- ▶ Turn the device off.

When the device is switched on after 30 minutes of dwell time, the remaining program steps run immediately and automatically.

If the device is turned on before the 30 minute period is elapsed, the dwell time finishes first before the remaining steps of the intensive germ reduction program run.

Skip exposure phase

This function is required when the treatment unit needs to be used (for example in an emergency, at hospitals, etc.) even though the germ reduction procedure has already started.

Intensive germ reduction is in step 4:



- ▶ Press and hold down the "Hydroclean" and "Intensive germ reduction" keys.

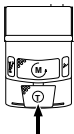

- ▶ Simultaneously press the foot pedal on the foot control.
- ⇒ The intensive germ reduction switches to step 3.7.
- ⇒ The automatic rinsing process starts up.

10.4 Reprocessing the suction system including suction hoses



Note

Clean the suction hoses after each treatment and disinfect them with DEKASEP-TOL Gel daily.

Application of DEKASEPTOL Gel

- ▶ Aspirate one tumbler of cold water with each suction hose.
- ▶ With the suction handpiece attached or by hand, press down the Dekaseptol dosing facility once each for the saliva ejector hose and the spray mist ejector.
- ▶ Aspirate DEKASEPTOL Gel (**Mat. no. 10007205**) from the dosing facility.
- ▶ Aspirate another tumbler of cold water with each suction hose.
- ▶ Then aspirate another dose of Dekaseptol and allow it to act.
- ▶ Place the suction hoses in the holder.

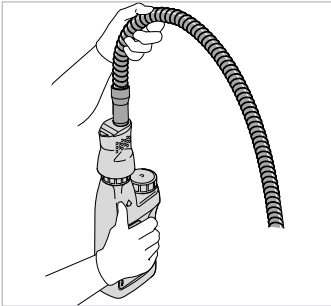

10.5 HYDROclean function

The following processes are triggered by the HYDROclean function:

- The suction lines (from the filter housing to the separator system) are rinsed automatically for 150 seconds with pure water by activating the selective valves and the suction machine.
- The bowl rinse is turned on and off several times.

Requirement

Suction hoses remain hanging in the holder.



- ▶ Press the "HYDROclean" button.
- ⇒ The HYDROclean function is in the preparatory stage.



- ▶ Press the "HYDROclean" button.
- ⇒ This starts-up the HYDROclean function.

The HYDROclean function is completed when the top LED goes dark.



The process can be discontinued at any time by pressing the "HYDROclean" button.

10.6 Replenishing Oxygenal

When the Oxygenal container is empty, a beep is issued every 10 seconds.

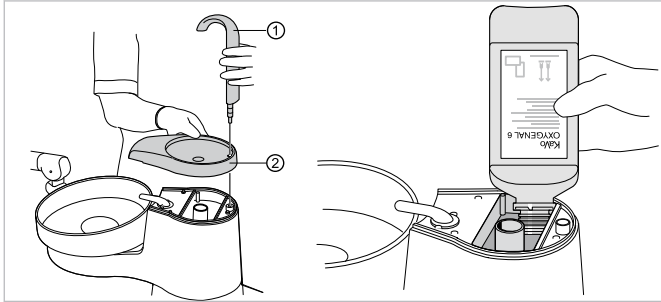

- ▶ Remove the tumbler filler ① and tumbler holder ②.
- ▶ Top off the Oxygenal (max. 1 litre).



Note

Do not fill through the centre opening (tumbler drain).







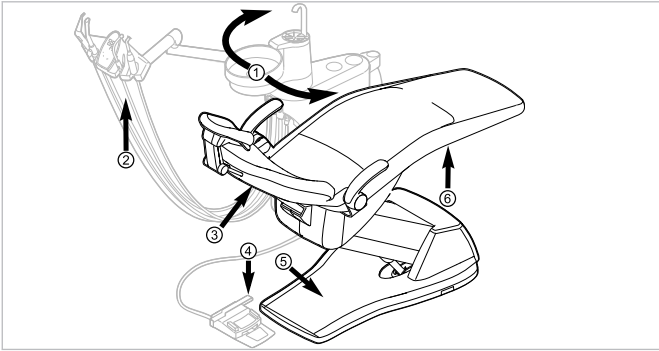





- ▶ Quit replenishing immediately if you hear a signal sound being issued every second (10 sounds).
⇒ Reservoir is full.
- ▶ Attach the tumbler holder and the tumbler filler.

11 Warning messages

11.1 Safety shut-off



Safety shutoff for the standard patient chair

Item No.	Safety switch-off actuated	LED on assistant element	LED on dentist element
①	Patient unit swung over the patient chair		
②	Assistant element		
③	Backrest		
④	Bracket on the foot control		
⑤	Kick plate		
⑥	Seat		

- ▶ To deactivate an activated safety shutoff, remove the triggers from the to the range of movement of the stool.

11.2 Additional warning messages

Malfunction	Cause	Remedy
A beep is issued every ten seconds and the "Intensive germ reduction" LED (green) flashes.	The Oxygenal container is empty.	<ul style="list-style-type: none"> ▶ Refill the Oxygenal container.
Ten beeps are issued.	The Oxygenal container is too full.	<ul style="list-style-type: none"> ▶ Stop filling the Oxygenal container.
A melody sounds.	The amalgam separator CAS1 is almost full (95%).	<ul style="list-style-type: none"> ▶ Exchange the amalgam container.
	The CAS1 amalgam separator is defective.	<ul style="list-style-type: none"> ▶ Also refer to: Instructions for use for the CAS 1 or ▶ Call a Service technician.
LED on "HYDROclean" button (red) flashes.	Malfunction in the amalgam separator.	<ul style="list-style-type: none"> ▶ Call a service technician. ▶ Note the amalgam separator warning notice. <p>Also refer to: Operating instructions of the amalgam separator</p> <p>See also:</p> <ul style="list-style-type: none"> ▶  Operating instructions of the amalgam separator
	Emergency shut off of the bowl valve (only when external suction is installed)	<ul style="list-style-type: none"> ▶ Call a technician.

12 Service and error messages in the stand-by menu

If a status message is available, the standby menu shows an exclamation mark on selection key "S2" ①.

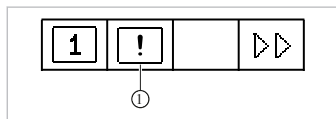

- ▶ Press the "S2" selection key ① to display status messages.

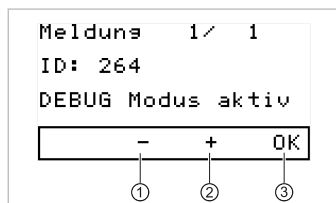

- ▶ Press the selection keys "+" ② and "-" ① to switch between multiple status messages.
- ▶ Press the "OK" selection key ③ to exit from the display of status messages.

Error messages in the status display

Malfunction	Cause	Remedy
Display shows: ID 33	No CAN node and/or internal communication is faulty.	▶ Call a service technician.
Display shows: ID 64	Water is shut off.	▶ Turn water on.
	Water works leaks strongly. Water works malfunction	▶ Call a technician.
Display shows: ID 65	Safety switch of bowl suction has been reached.	▶ Turn external suction on. ▶ Check and clean, if required, the bowl valve.
Display shows: ID 66	Amalgam separator malfunction	▶ Remedy the malfunction. See also: 📖 Instructions for Use of amalgam separator
Display shows: ID 67	The oxygenal container is empty.	▶ Refill the Oxygenal container. See also: 📖 Servicing instructions
Display shows: ID 68	Call for service	▶ Have a service performed. ▶ Call a technician.

Malfunction	Cause	Remedy
Display shows: ID 69	Intensive germ reduction must be done.	<ul style="list-style-type: none"> ▶ Carry out an intensive germ reduction. <p>See also:</p> <ul style="list-style-type: none"> ▣ Servicing instructions
Display shows: ID 70	Dekaseptol empty.	<ul style="list-style-type: none"> ▶ Replenish Dekaseptol. <p>See also:</p> <ul style="list-style-type: none"> ▣ Servicing instructions
Display shows: ID 72	Dekaseptol bottle.	<ul style="list-style-type: none"> ▶ Insert the DEKASEPTOL bottle. <p>See also:</p> <ul style="list-style-type: none"> ▣ Care instructions
Display shows: ID XX	This error is not described in this chapter.	<ul style="list-style-type: none"> ▶ Call a technician.
Display shows: CAN fail	Internal communication error.	<ul style="list-style-type: none"> ▶ Turn the unit off and on again, consult a service technician according to need.
Display shows: System State	Unit does not work.	<ul style="list-style-type: none"> ▶ Call a service technician.

