



CS 1500



User's Guide

Notice

No part of this publication may be reproduced, stored in a retrieval system, translated to another language, or transmitted in any form by any means, electronic, mechanical, photocopied, recorded, or otherwise, without prior written permission.

The information in this document is subject to change. Neither Carestream Health, Inc. nor any of its subsidiaries shall be liable for errors contained herein or for incidental damages in conjunction with the furnishing, performance, or use of this material.

We recommend that you thoroughly familiarize yourself with this Guide in order to make the most effective use of your system.



WARNING: We recommend that you consult the “Safety Sheet” and the “Safety and Regulatory Guide” before using the CS 1500 Systems.

Carestream Health is a trademark of Carestream Health, Inc.

All other trademarks and registered trademarks are the property of their respective holders.

US Federal law restricts this device to sale by or on the order of a dentist.

The CS 1500 intraoral camera is also marketed and sold as the WAVE PICT + intraoral camera.

Manual Name: *CS 1500 Intraoral Camera User's Guide*

Part Number: 9H0951

Revision Number: 04

Print Date: 2014-10



Contents

Chapter 1 Conventions in This Guide	Conventions in This Guide	1
Chapter 2 CS 1500 System Packaging	CS 1500 System Description Packaging of the CS 1500 Camera	3 3
Chapter 3 CS 1500 Intraoral Camera Overview	Camera Overview. Wired USB Camera Overview Wireless Camera Overview Camera Holder Components Overview Docking Station Components Overview (Wireless). Charge Station Components Overview (Wireless) Rapid USB Cable Overview	6 6 7 8 9 10 11
Chapter 4 CS 1500 Software Overview	Minimum Computer System Requirements General Software Overview Acquisition Interface Overview. Toolbar Overview. Video Toolbar Image Toolbar Common Video and Image Toolbar Image Gallery Toolbar Dialog Box Overview. Image Processing Dialog Box. Tooth Chart Dialog Box Preferences Dialog Boxes Overview General Preferences Video Adjustment Preferences Tools Preferences	13 13 14 14 14 15 15 16 16 16 17 18 18 19 19
Chapter 5 Setting Up the CS 1500 Intraoral Camera	CS 1500 Camera Configuration Options Option 1: Single Camera/Single Computer Option 2: Single Camera/Several Computers Option 3: Single Camera/Single Monitor	21 21 22 22

	Installing the Software.	23
	Upgrading the Firmware.	25
	Setting up the Wired USB Camera.	29
	Setting up the Wireless Camera	31
	Using the Charge Station as a Stand-Alone Device.	34
	Pairing the Wireless Camera to the Docking Station	35
	Installing the Camera Holder	37
	Connecting the Docking Station to a Video Monitor.	39
	Video Monitor Equipment Status Icons	41
Chapter 6	Accessing the Acquisition Interface	43
Getting Started	Setting up Preferences	43
	Using Imaging Software with TWAIN.	44
	Starting the Imaging Software	44
	Setting Up Preferences.	44
Chapter 7	Preparing for Acquisition	45
Recording Video	Preparing the Camera	45
and Capturing Im-	Recording Video and Capturing Images on a Computer.	46
ages	Recording and Viewing Videos.	46
	Capturing and Viewing Images.	47
	Acquiring Images Using Different Computers	48
	Acquiring Images Using a Video Monitor	48
Chapter 8	Cleaning and Disinfecting	51
Maintenance		
Chapter 9	Manufacturer's Address.	53
Contact Information	Authorized Representatives	53
	Authorized Representative in the European Community	53
	Importer for European Union	53
	Representante no Brasil Carestream do Brasil Comércio e	
	Serviços de Produtos MédicosLtda.	53

1 Conventions in This Guide

Conventions in This Guide

The following messages emphasize information or indicate potential risk to personnel or equipment:



WARNING: Warns you to avoid injury to yourself or others by following the safety instructions precisely.



CAUTION: Alerts you to a condition that might cause serious damage.



Important: Alerts you to a condition that might cause problems.



Note: Emphasizes important information.



Tip: Provides extra information and hints.

2 CS 1500 System Packaging

CS 1500 System Description

The CS 1500 system is available in two configurations:

- Wired USB
- Wireless

See “[Packaging of CS 1500 Camera](#)” for the packaging components list. Inspect the packages of the CS 1500 intraoral camera after the shipment is received. If there are any signs of damage or missing parts, contact the shipping company and Carestream Health, Inc, immediately.

Packaging of the CS 1500 Camera

The CS 1500 intraoral camera packaging is composed of the following boxes:

- Camera box
- Accessories and components box

Table 1 Packaging of CS 1500 Camera













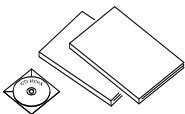

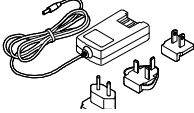
	Description	Quantity
	CS 1500 intraoral camera handpiece	1
	Docking station (Wireless ONLY)	1
	Camera holder	1
	Document and software package: <i>Intraoral Camera Installation Wizard DVD</i> <i>Documents on DVD:</i> <ul style="list-style-type: none">• User's Guide• Safety and Regulatory Guide• Safety Information Sheet• Troubleshooting Guide• Quick Start Guide <i>Documents Printed:</i> <ul style="list-style-type: none">• E-Labeling Information Sheet• Warranty Sheet• Quick Start Guide	

Table 1 Packaging of CS 1500 Camera

	Description	Quantity
	Charge station (Wireless ONLY)	1
	DC power cable and adapters (Wireless ONLY)	
	Rechargeable batteries (Wireless ONLY)	2
	Docking station antenna (Wireless ONLY)	1
	4G SD card (Wireless ONLY)	1
	Charge station power cord (Wireless ONLY)	1
	S-video cable (Wireless ONLY)	1
	AV cable (Wireless ONLY)	1
	Camera cable with one USB connection to the docking station (Wireless ONLY)	
	Rapid USB cable (Wired USB ONLY)	1
	1 additional USB cable with two USB connections. It is used only if the traditional USB cable with one USB connection cannot provide enough power to the camera.	1
	Protective sheaths	20

3 CS 1500 Intraoral Camera Overview

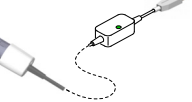
The CS 1500 intraoral camera is a high quality dental imaging system, featuring 1mm-to-infinity auto-focus range, liquid lens technology, and breakthrough WiFi technology. The camera brings a new level of usability to dental professionals to plan treatment and guide patients to more informed treatment decisions.

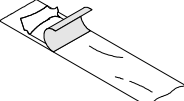
The wired USB and wireless cameras, when connected to the computer, can do the following:

- Record videos
- Capture images
- View live video, recorded videos, and captured images
- Store recorded videos and captured images

The wireless camera, when connected to the monitor, can do the following:

- Captures images
- Views live video and captured images
- Stores captured images





Camera Overview

Wired USB Camera Overview

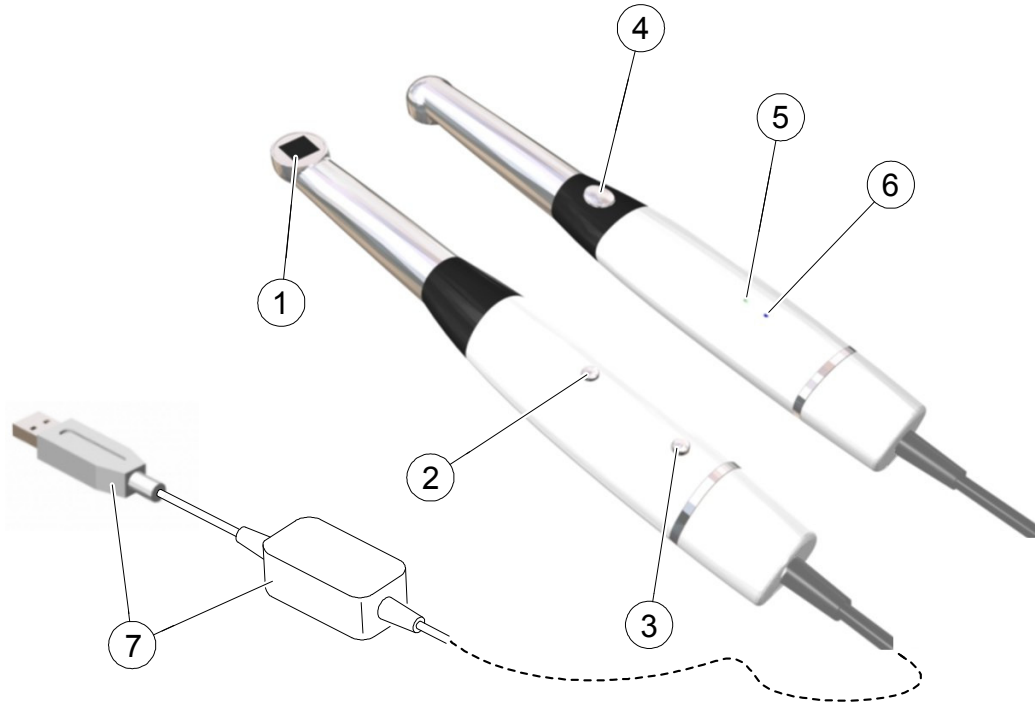
The wired USB camera can be connected to the computer using a Rapid USB cable.

Figure 1 Wired USB Camera Components Overview





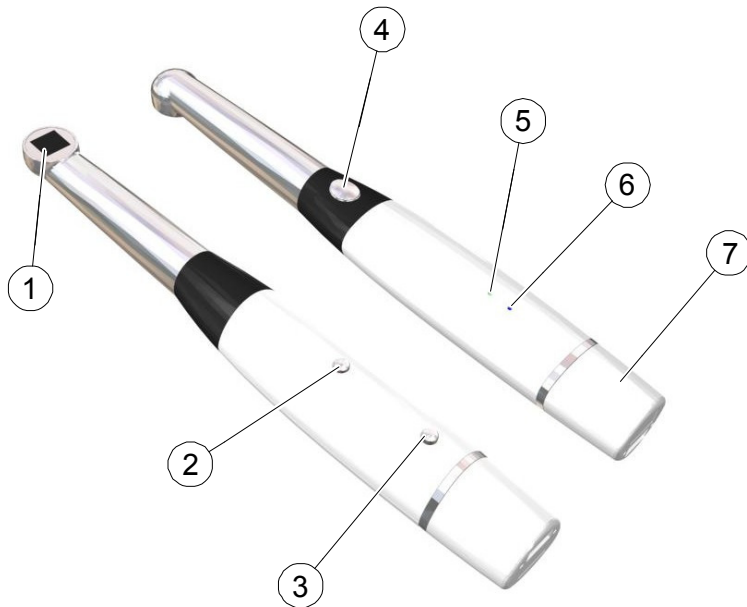

- | | | |
|---|--------------------------|--|
| 1 | LED and Lens window | View white LEDs that illuminate the oral cavity. |
| 2 | Power ON/OFF button | <ul style="list-style-type: none"> • Press 3 seconds to power ON. • Press 5 seconds to power OFF. |
| 3 | Cable Release button | Press button and pull cable out. |
| 4 | Shutter Release button | <ul style="list-style-type: none"> • Press halfway down to perform auto focus. • Press all the way down to capture an image. • Press halfway down and release to return to preview mode. |
| 5 | Power indicator | <ul style="list-style-type: none"> •  indicates the power is ON. •  indicates the power is going to go Off. •  indicates the power is OFF. |
| 6 | USB connection indicator | <ul style="list-style-type: none"> •  indicates the USB connection is normal. •  indicates no connection. |
| 7 | Rapid USB Cable | Insert one end of the cable into the bottom of the camera until it fits tightly in place; insert the USB end of the cable into the computer USB port tightly. |

Wireless Camera Overview

Figure 2 Wireless Camera Components Overview



- | | | |
|---|------------------------|--|
| 1 | LED and Lens window | View white LEDs that illuminate the oral cavity. |
| 2 | Power ON/OFF button | <ul style="list-style-type: none">• Press 3 seconds to power ON.• Press 5 seconds to power OFF. |
| 3 | Battery Release button | Press button and pull battery out. |
| 4 | Shutter Release button | <ul style="list-style-type: none">• Press halfway down to perform auto focus.• Press all the way down to capture an image.• Press halfway down and release to return to video mode. |
| 5 | Battery indicator | <ul style="list-style-type: none">•  indicates the battery is charged and working properly.•  indicates the battery is low.•  indicates the power is OFF. |
| 6 | WiFi indicator | <ul style="list-style-type: none">•  indicates the wireless connection is normal.•  indicates no connection. |
| 7 | Battery | Insert rechargeable battery into the bottom of the camera until it fits tightly in place. |

Camera Holder Components Overview

Place the camera in the holder when you are not using the camera.

Figure 3 Camera Holder Components Overview

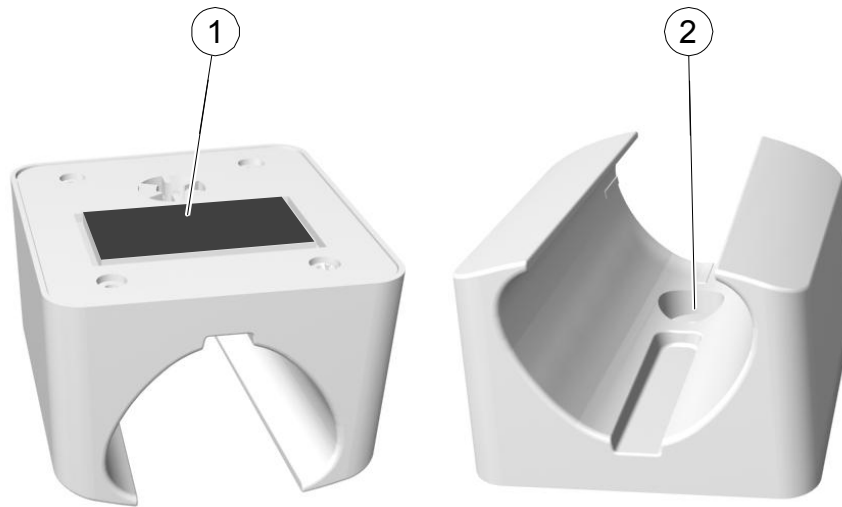

- 1 Adhesive tape
- 2 Opening to fasten the holder securely to the surface using a screw



Note: The camera reverts to sleep mode when it is in the holder. If the camera is in the holder for more than 3 hours(default), it shuts down. To change the default automatic power-off time, see [“General Preferences”](#).

Docking Station Components Overview (Wireless)

The docking station provides power to the camera and enables you to connect the camera to a computer or a video monitor. The docking station contains the SD card socket and all the connections to use the camera.

Figure 4 Docking Station Front, Back, and Bottom View Components

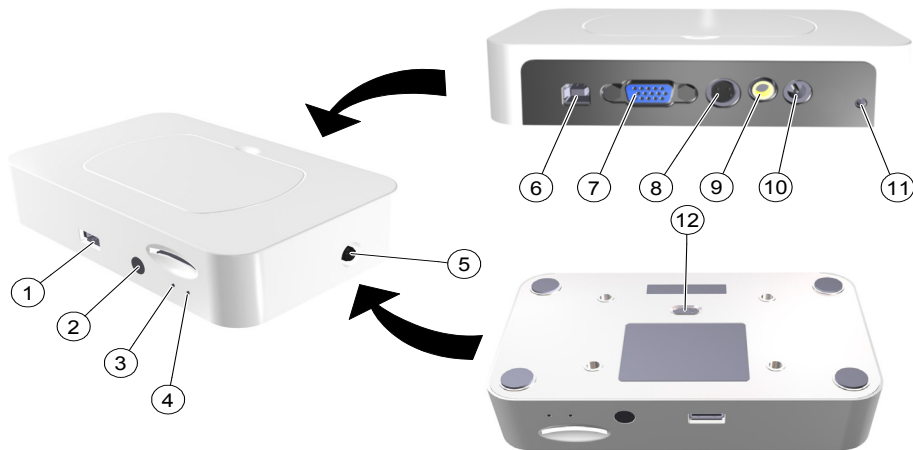

1 USB connector to the camera

2 SD card socket

3 Power indicator

•  indicates the power is ON.

•  indicates the power is OFF.

4 WiFi indicator

•  indicates the connection is normal.

•  indicates no connection.

5 Antenna connector

6 USB connector to the computer

7 VGA connector

8 S-video connector

9 AV-out connector

10 Power DC-in connector

11 DC-out connector

12 Output switch: NTSC, PAL, S-Video, VGA

Charge Station Components Overview (Wireless)

The charge station charges the battery in the wireless camera and the additional battery simultaneously or separately. You can use the charge station as a stand-alone unit or attach it to the docking station. The power for the charge station comes from the docking station or from the power adapter if it is used as a stand-alone unit.

It takes 2 hours to charge the battery. A fully charged battery lasts approximately 45 minutes.





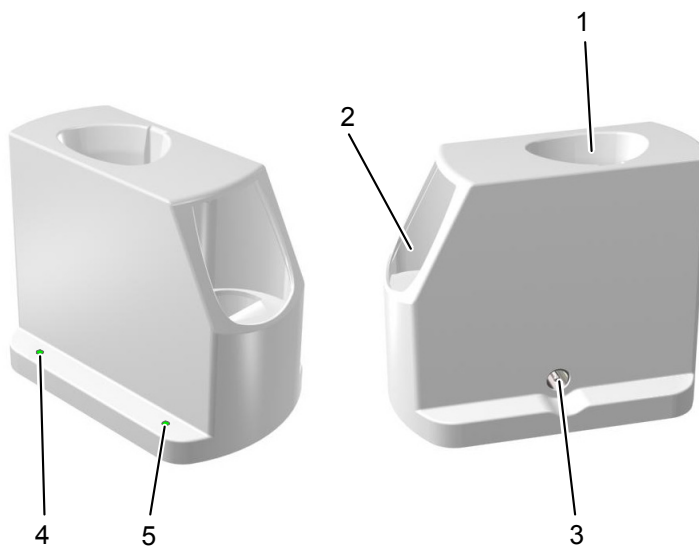

Important: As with all lithium-ion batteries, the discharge time will slowly decrease over time. When the discharge time becomes too low to perform operations, the battery must be replaced.





Figure 5 Charge Station (Wireless) Components Overview



- 1 Camera port
- 2 Additional battery port
- 3 Power input
- 4 Camera indicator

-  indicates the charging is completed.
-  indicates the charging is in progress.
-  indicates a poor contact. Re-insert the camera.
-  indicates no camera or no power to the charge station.

5 Battery indicator

-  indicates the charging is completed.
-  indicates the charging is in progress.
-  indicates a poor contact. Re-insert the battery in place.
-  indicates no battery or no power to the charge station.



Note: The camera reverts to sleep mode when it is in the charge station.



Note: If the camera is in the charge station for more than 3 hours (default), it shuts down. To change the default automatic power-off time, see [“General Preferences”](#).

Rapid USB Cable Overview

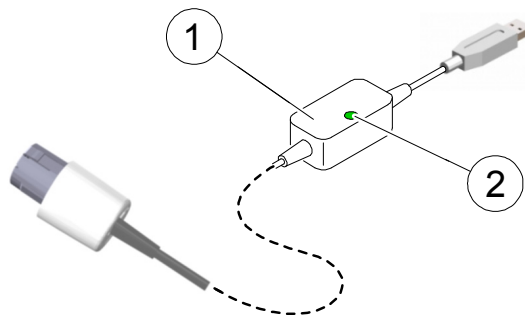

The Rapid USB Cable is used for data transmission and uninterrupted power supply, with an embedded battery. It is intended to reduce the start-up time by avoiding the power-off and power-on cycle when moving the camera between computers or docking stations. When the cable is connected to the computer or docking station, the USB power supply charges the embedded battery. When the cable is not connected to computer or docking station, the camera is powered by the embedded battery and kept in the power saving mode. If not connected to the computer or docking station within 30 minutes, the camera turns off automatically. The cable can be used with the Intraoral Camera (Wired USB and Wireless models) with Firmware 1.1.5.X / 1.0.5.X or above.

Figure 6 Rapid USB Cable Overview



1 Battery

2 Battery indicator

-  indicates the battery is charged.
-  indicates the battery charging is in progress.
-  indicates the battery is not being charged.

4 CS 1500 Software Overview

Minimum Computer System Requirements

For the minimum computer system requirements, see the **CS 1500 Intraoral Camera Safety and Regulatory Guide**.



Important: It is **MANDATORY** to check that your computer system configuration is compatible with the computer system requirements for the CS 1500.

General Software Overview

The CS 1500 intraoral imaging system operates with the following software:

- Carestream's Dental Imaging Software
- Imaging software using TWAIN interface
- **Acquisition** interface

Acquisition Interface Overview

The **Acquisition** interface is a user-friendly working interface that was designed and developed specifically for the CS 1500. It can acquire and review videos and images of the oral cavity and export them to the Dental Imaging Software for storage.

Figure 7 Acquisition Interface Overview

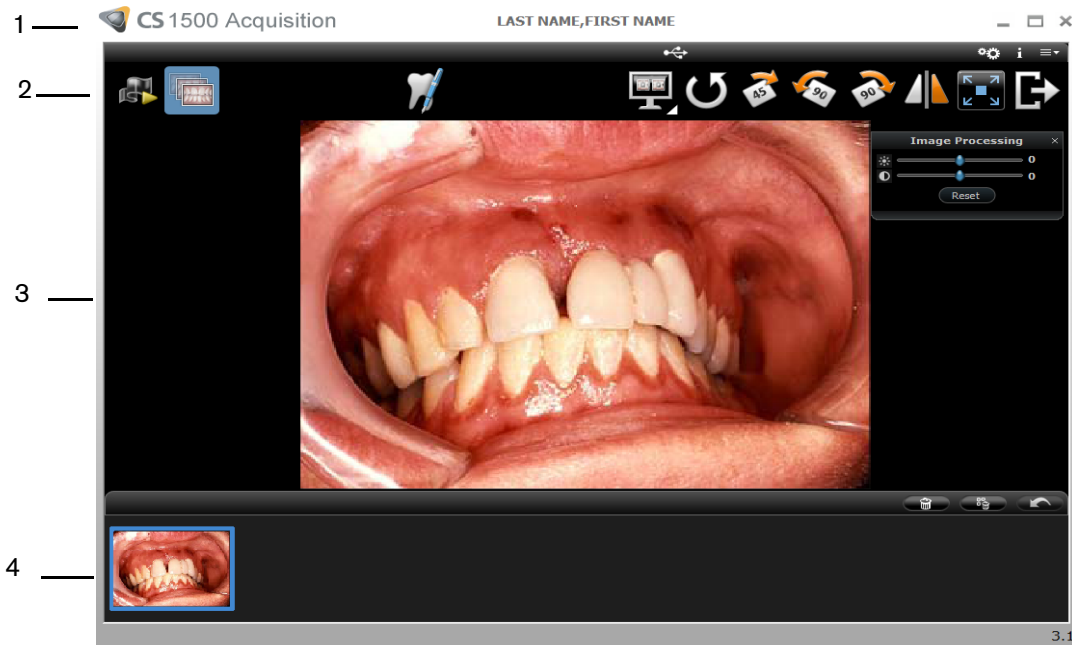

- 1 Title Bar:** Displays the patient's name.
- 2 Toolbar:** See "[Toolbar Overview](#)."
- 3 View Screen:** Displays live video, selected captured image, or recorded video.
- 4 Image Gallery:** Displays thumbnails of all captured images and recorded videos.

Toolbar Overview

The Toolbar enables you to manage the following features:

- Live video recording, viewing, and managing features.
- Image capturing, viewing, and managing features.

Video Toolbar

The video toolbar enables you to launch, record, and play a live or recorded video.



Video record button: Records a live video.



Play button: Plays a recorded video.



Pause button: Pauses a recorded video.



Stop button: Stops a recorded video.

Image Toolbar

The image toolbar enables you to capture, view, and manage a still image.



Capture button: Captures an image.



Reset button: Clears all changes made to an image.



Rotation button: Rotates an image 45°.



Rotation button: Rotates an image 90°.



Rotation button: Rotates an image anti-clockwise 90°.

Common Video and Image Toolbar

The following buttons are shared by video and image screens:



Live video button: Launches the live video.





Review button: Reviews images and recorded videos.



Tooth chart comment button: Accesses the tooth chart dialog box to associate a tooth/teeth with the selected image and enables you to write comments in the **Comments** field.



Select a format button: Click  to access the last selected format. Click  to access the **Select a format** dialog box to select a new display format.



Mirror image and Video button: Mirror the live video and the captured images.



Full screen button: Displays the live video, recorded video, and the captured images in full screen.



Exit button: Closes the **Acquisition** interface.



USB connection status icon: Displays the camera USB connection status. If the icon is red, the USB is disconnected.



Preference button: Accesses the preference dialog box.



Information button: Accesses information on the software version, firmware version, and camera serial number.



Online help button: Accesses the online help.



Wireless connection status icon: Displays the wireless camera connection status. If the icon is red, the wireless camera is disconnected.



Appears when the camera enters sleep mode.

Image Gallery Toolbar

The image gallery toolbar enables you to manage videos and images displayed in the image gallery.



Delete button: Deletes selected images and recorded videos.



Delete all button: Deletes all images and recorded videos in the image gallery.



Restore button: Restores the last deleted image or recorded video.

Dialog Box Overview

Image Processing Dialog Box

The image processing dialog box enables you to manage the image contrast and brightness.

Figure 8 Image Processing Dialog Box

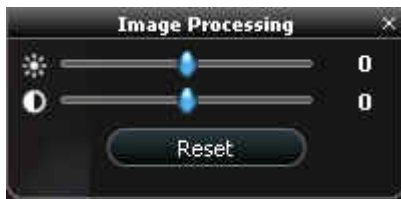

Brightness button: Adjusts the brightness of the image.



Contrast button: Adjusts the contrast of the image.



Scroll button: Increases or decreases the brightness and contrast of the image.



Reset button: Clears all brightness and contrast changes made to the image.

Tooth Chart Dialog Box

The tooth chart dialog box enables you to select tooth numbers associated with the image or video.

Figure 9 Tooth Chart

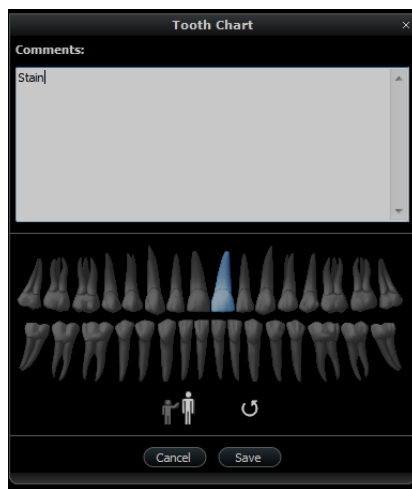

Comments:

Comments field: Enables comments to be associated with an image or video.



Dental arch: Enables tooth selection.



Child dental arch: Enables tooth selection for a child.



Reset button: Clears all tooth selections.

Cancel

Cancel button: Cancels all tooth selections.

Save

Save button: Saves tooth selections.

Preferences Dialog Boxes Overview

The preference dialog boxes enable you to select the camera and **Acquisition** software settings. Set up your preferences before using the camera.

General Preferences

Figure 10 General Preferences



General Preferences enable you to:

- **Language:** Select the menu language.
- **Tooth numbering system:** Select the tooth numbering system.
- **2 Level capture:** Enable/disable the two level capture feature.
- **Frequency setting:** Select the local electric frequency.
- **Power off automatically:** Select the automatic power off time, from 1-9 hours. The default time for powering off automatically is 3 hours.
- **Capture sound:** Enable/disable the audio sound when an image is captured.
- **Record sound:** Enable/disable the audio sound when a video is recorded.



Important: Ensure that the proper frequency setting is selected for your region. The wrong setting can negatively impact image quality.

Video Adjustment Preferences

Figure 11 Video Adjustment Preferences

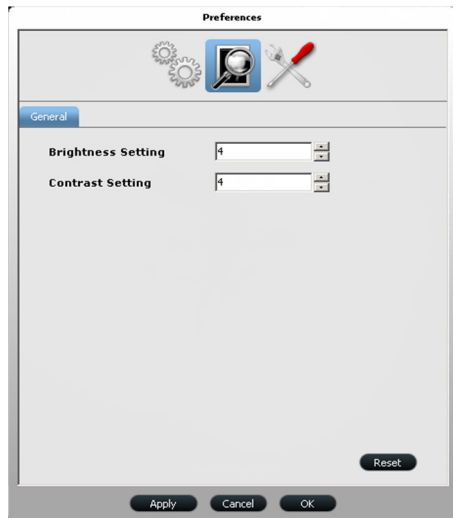

Video Adjustment Preferences enable you to adjust the following settings:

- **Brightness Setting:** Select the video brightness setting.
- **Contrast Setting:** Select the video contrast setting.

Tools Preferences

Figure 12 Tool Preferences

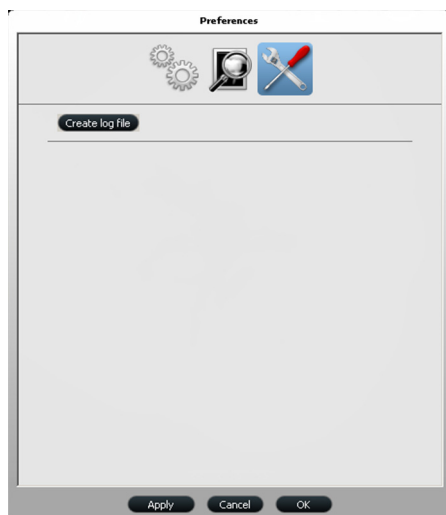

Tool Preferences enable you to save log files for service information.

5 Setting Up the CS 1500 Intraoral Camera

CS 1500 Camera Configuration Options

Option 1: Single Camera/Single Computer

- Single wired USB camera, directly connected to the computer configuration (see **“Setting up the Wired USB Camera”**).

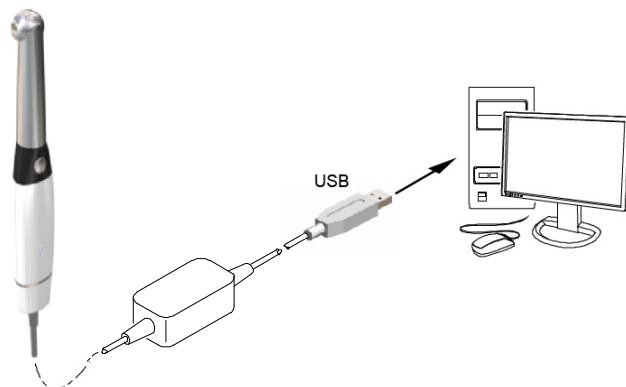

- Single wireless camera, connected to the computer using the docking station configuration (see **“Setting up the Wireless Camera”**).

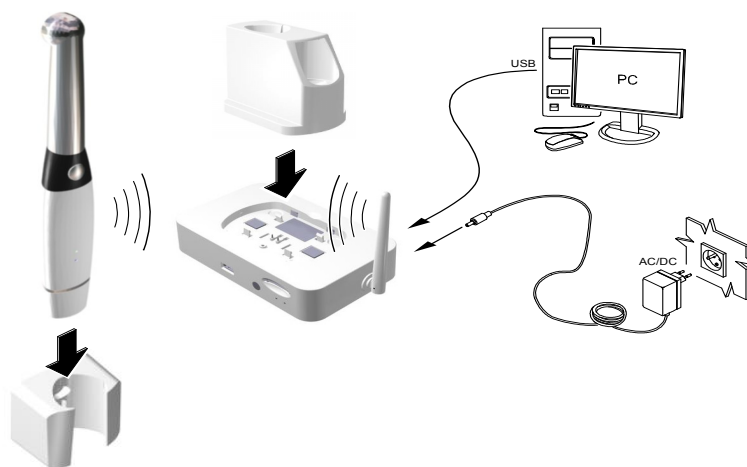

Option 2: Single Camera/Several Computers

- Single wired USB camera, connected to several computers (one computer at a time) using a USB configuration (see [“Setting up the Wired USB Camera”](#)).

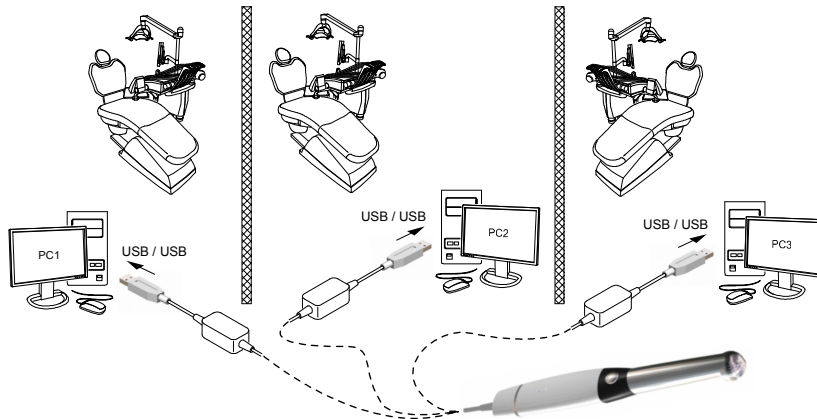

- Single wireless camera, connected to several computers using the docking station configuration (see [“Pairing the Wireless Camera to the Docking Station”](#)).

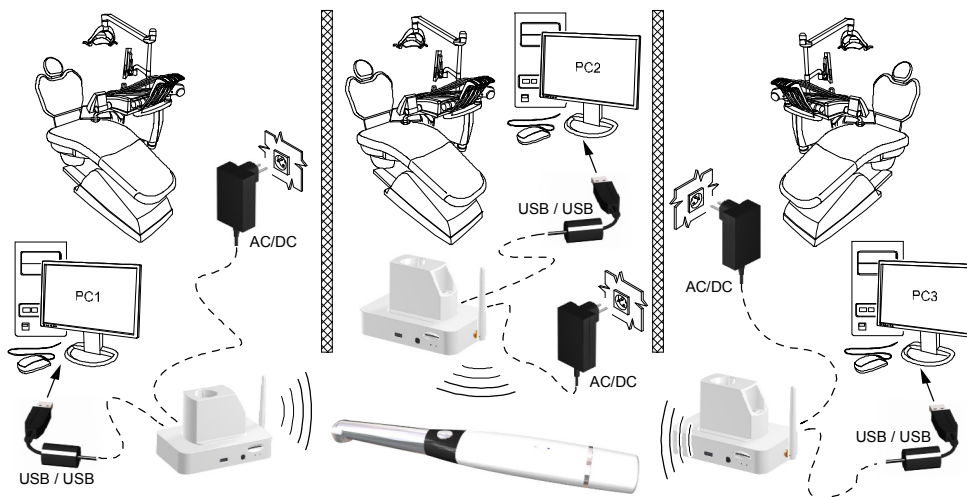

Option 3: Single Camera/Single Monitor

- Single wireless camera, connected to the monitor using the docking station configuration (see [“Connecting the Docking Station to a Video Monitor”](#)).

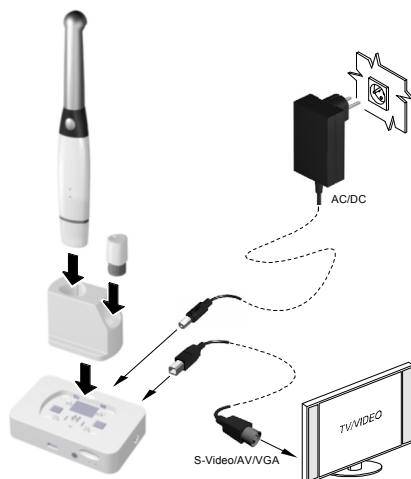

Installing the Software

To install the software on the computer, follow these steps:

- 1 Insert Carestream's **Dental Imaging Software Suite** DVD to install the Dental Imaging Software (see the Dental Imaging Software installation guide).

To install the imaging software using TWAIN interface, see your imaging software user guide.

- 2 Insert the **Drivers** DVD to install the Intraoral Camera driver. The **Choose Setup Language** dialog box is displayed. Select the installation language and click **OK**.

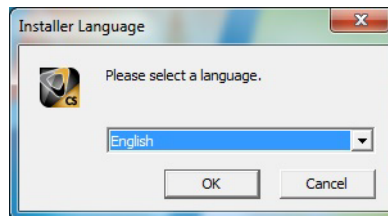

When you are prompted with the **Choose Components** screen, select **CS 1200/ CS 1500/ CS 1600**.

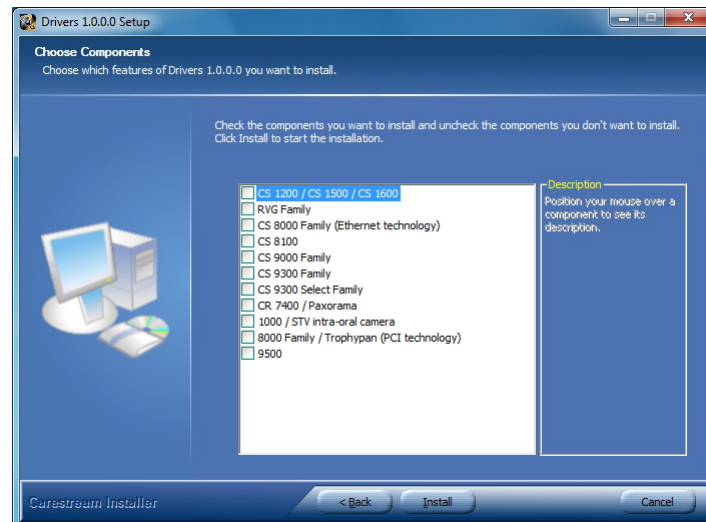

For TWAIN users, insert the **CS Intraoral Cameras Installation Wizard DVD**. If the DVD does not run automatically, navigate to your DVD drive in Windows Explorer and double-click the **Launcher.exe** file.

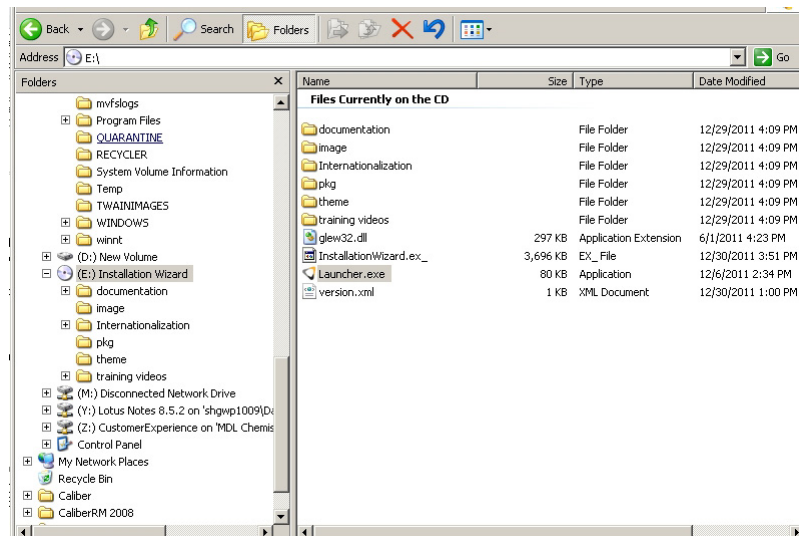

- 3 Follow the on-screen instructions to install the **Acquisition** interface and set up the camera.
If you are prompted with the following pop-up:

- Check **Always trust software from "Carestream Health"** and click **Install**.



Upgrading the Firmware

If you install a newer version of **Acquisition** Interface software, you may need to upgrade the firmware. To upgrade the firmware, follow these steps.

- 1 Connect the camera to the computer.
 - For the wired USB camera, see “[Setting up the Wired USB Camera](#)”.
 - For the wireless camera, connect the wireless camera to the docking station with the USB cable. For the docking station connection, see “[Setting up the Wireless Camera](#)”.
- 2 Access the **Acquisition** Interface, see “[Accessing the Acquisition Interface](#)”. A message asks you to upgrade the firmware.
 - Wired USB Camera

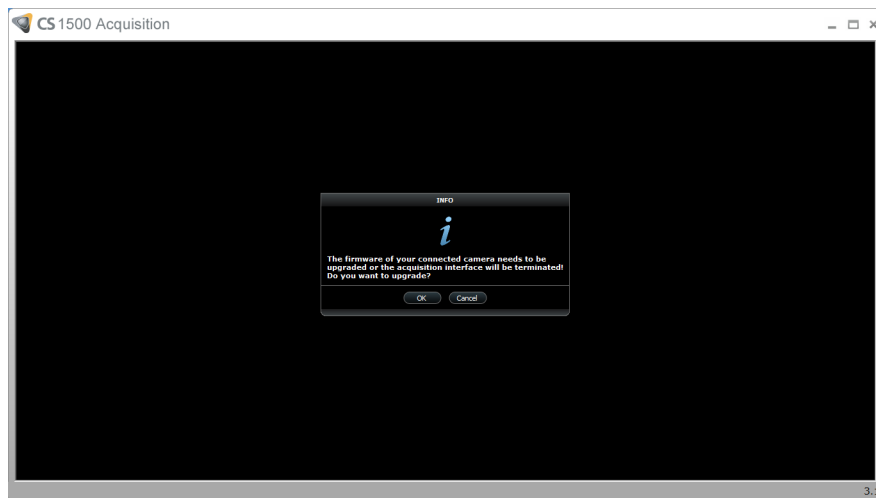

- Wireless Camera

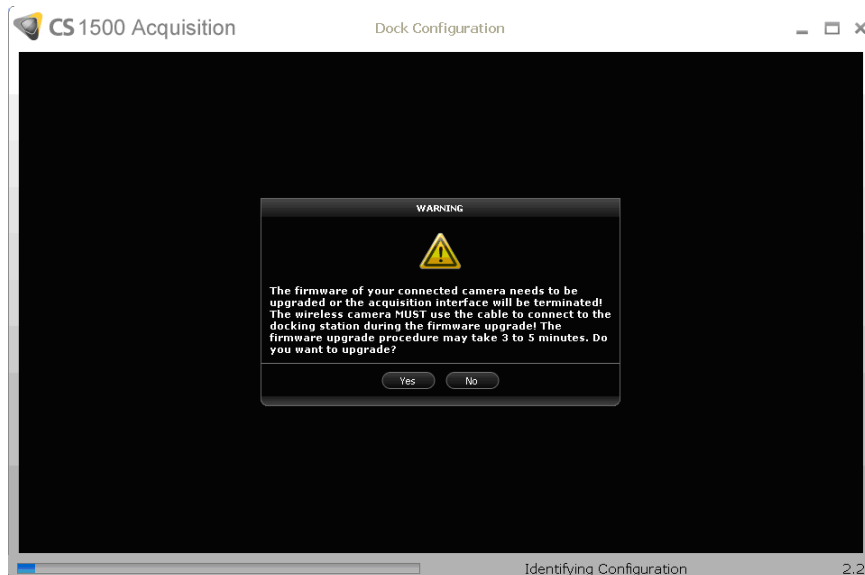

- 3 Click **Yes**. The firmware upgrade starts and the following windows are displayed.

- Wired USB Camera

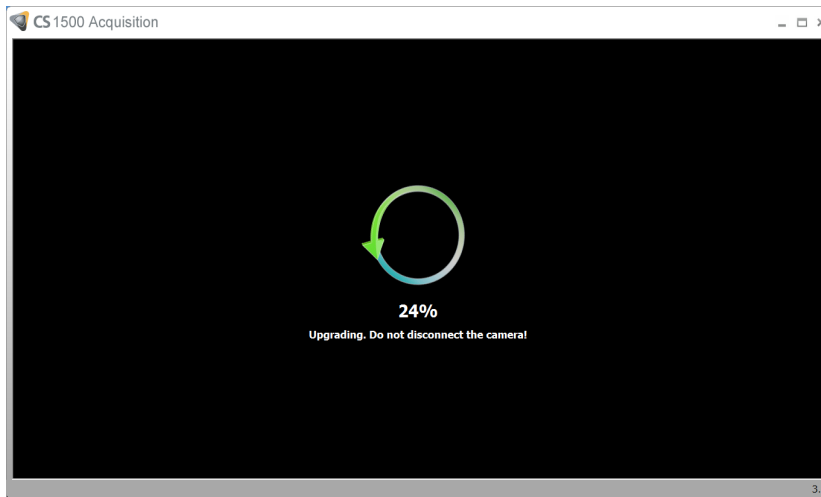

- Wireless Camera

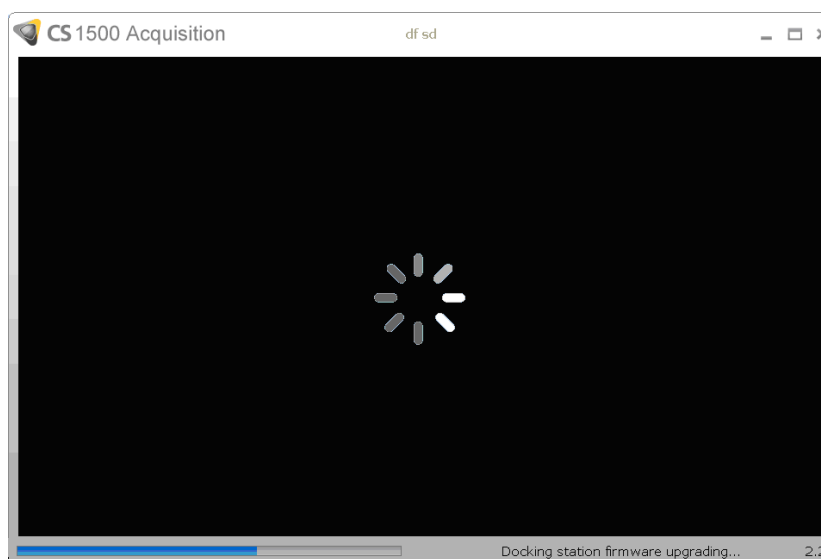
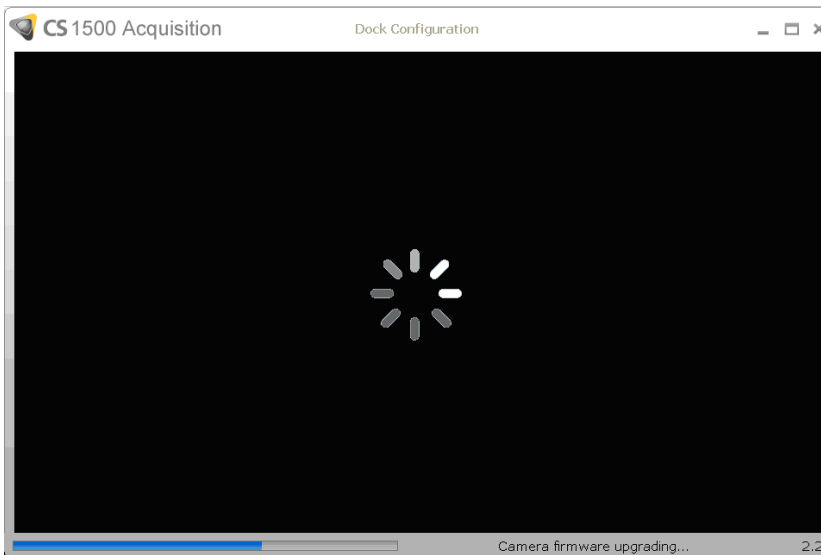

- 4 When the firmware upgrade is complete, you are prompted to restart the **Acquisition** Interface, camera, and docking station.

- Wired USB Camera

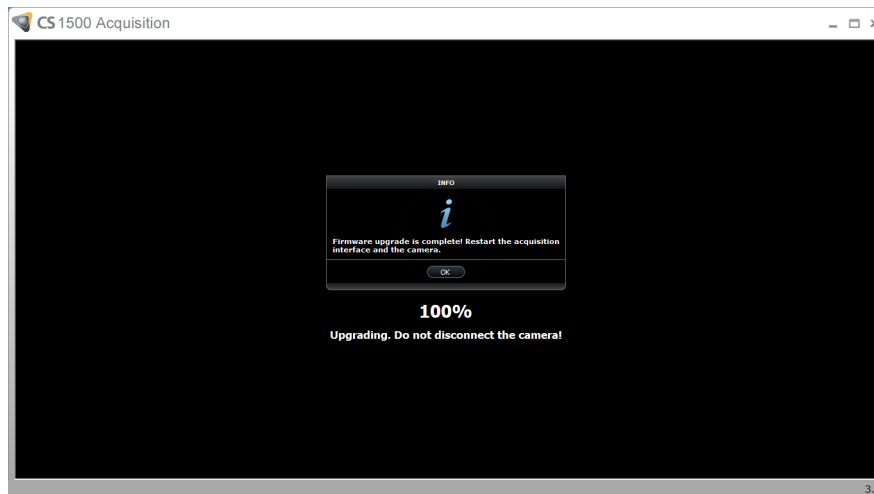

- Wireless Camera

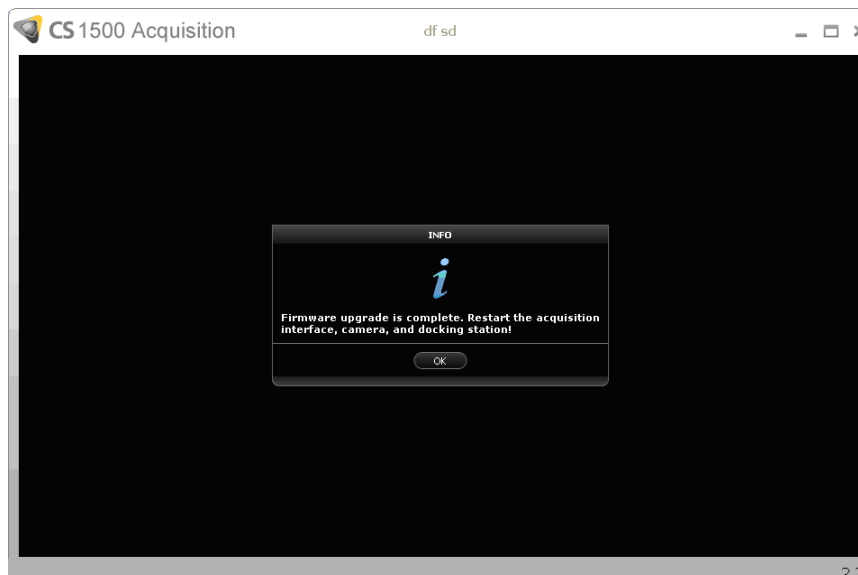

- 5 Click **OK** and then do one of the following.
 - For the wired USB camera, restart the camera by unplugging the rapid USB cable end that is connected with the camera.
 - For the wireless camera, restart the camera by unplugging the USB cable and restart the docking station by unplugging the power cable.
- 6 Make sure that the firmware upgrade is successful.
 - Reopen the **Acquisition** Interface to see a live video without the firmware upgrade notification.

- Open the Information panel, and make sure the firmware version has been updated. For the wireless configuration, the docking station and the camera should be the same firmware version.



Setting up the Wired USB Camera

You can connect the wired USB camera directly to a computer, or several computers (one computer at a time).



Important: Before connecting the camera and installing the camera network driver, you must have a Windows Administrator account.

To connect the camera directly to the computer, follow these steps:

- 1 Hold the camera in one hand and insert the cable end into the bottom of the camera.

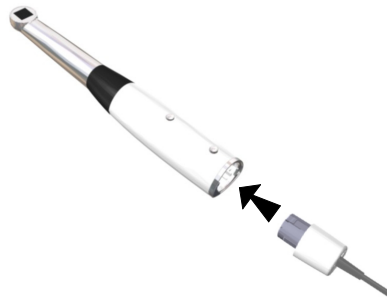

If you need to release the cable, press the Cable Release (A) button and gently pull the cable out.

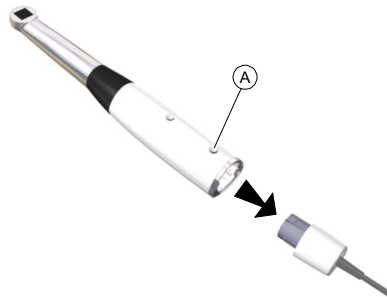

- 2 Make sure the cable is locked into place.
- 3 Insert the USB end of the cable into the USB port of the computer.

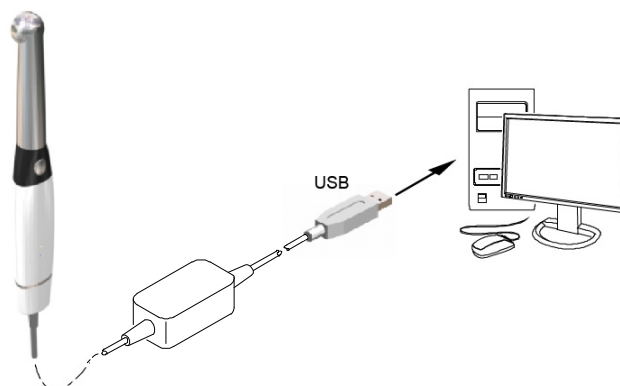



Note: If you use a desktop computer, connect the camera cable to the USB port located at the back of the computer.



Note: If the traditional USB cable with one connection to the computer cannot provide enough power to the wired USB camera, use the additional dual USB cable with two connections that is provided.

- 4 Press for 3 seconds to power ON the camera.

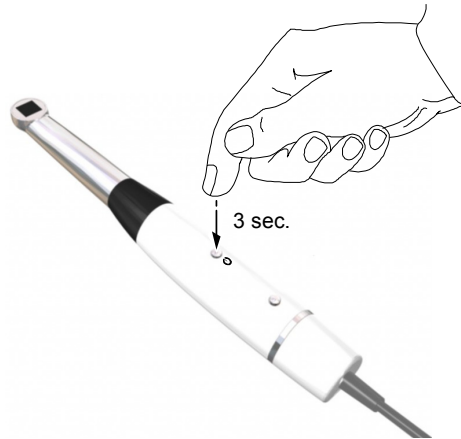

Setting up the Wireless Camera

To set up the wireless camera to the computer using the docking station, follow these steps:

- 1 Screw the antenna into the connection on the right side of the docking station. Make sure the antenna is screwed tightly (not too tightly) into the connection.



Important: A loose connection can negatively impact wireless range for the camera.



- 2 Connect the computer USB cable (A) to the docking station and the other end of the USB cable to the computer USB port (B). Connect the DC power supply (C) into the docking station. Insert the DC power cord into the power outlet (D).

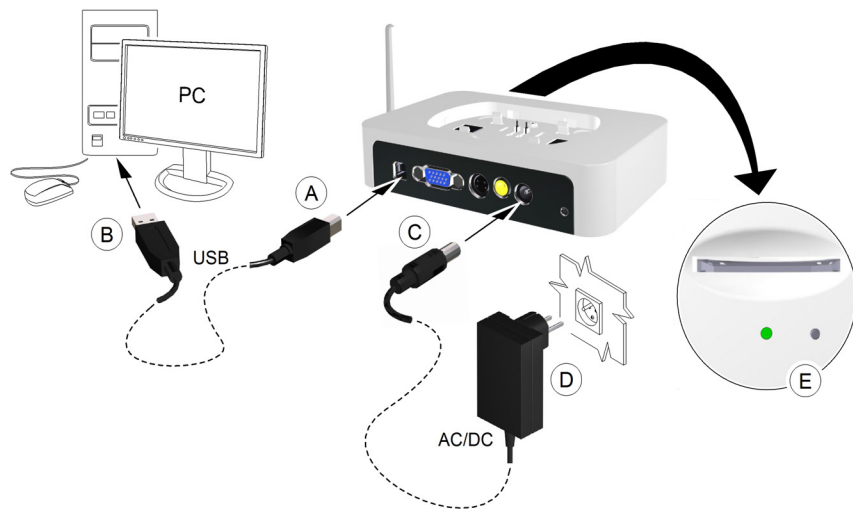

The docking station power indicator on the front of the docking station turns green (E).

- 3 Remove the top cover (A) from the docking station. Place the charge station (B) on top of the docking station. Verify the connections and align the section correctly. Press it into place.

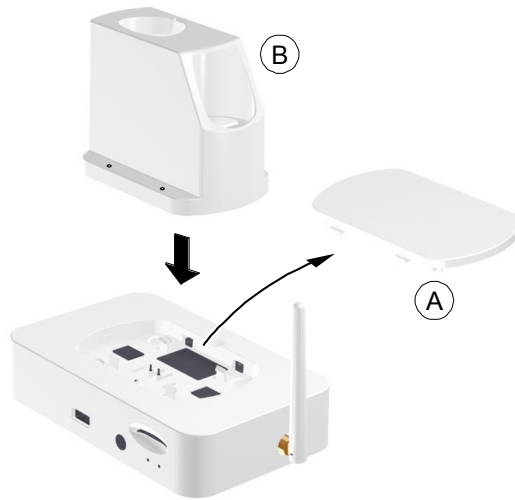

For a stand-alone charge station setup, see [“Using the Charge Station as a Stand-Alone Device”](#).

- 4 Hold the camera in one hand, and with your other hand push the battery into the bottom of the camera.

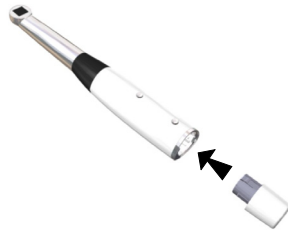

If you need to release the battery, press the Battery Release button (A) and gently pull the battery out.

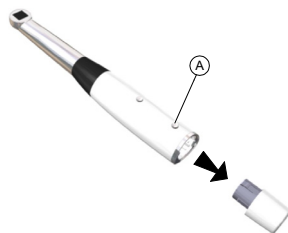

Make sure the battery locks into place.

- 5 Place the camera into the charge station.

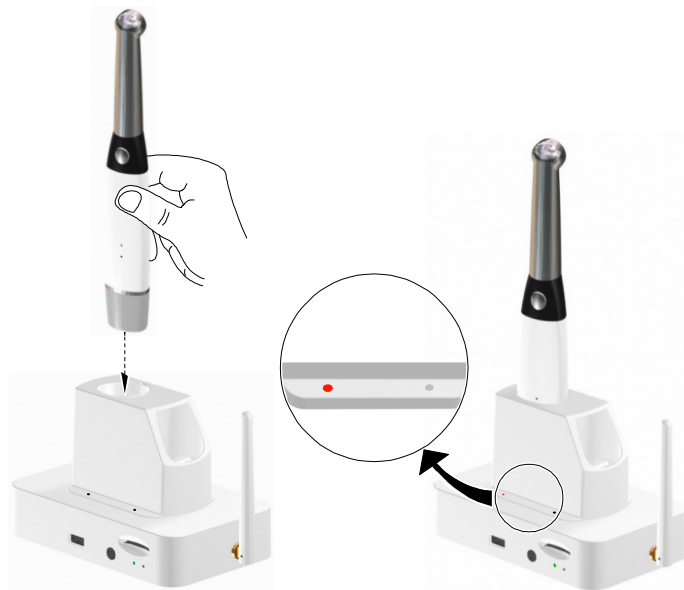

- 6 Place the additional battery in the charge station (A) and push it down (B) to hold in place. This will allow you to always have an additional charged battery to use.



The left LED indicator (C) displays the camera charging status; it becomes solid orange when charging is in process.

The right LED indicator (D) displays the battery charging status; it becomes solid orange when charging is in process.

When the left (C) or the right (D) LED indicator become solid green, the charging is completed.



Important: If an indicator light is flashing, you must re-insert the camera or the battery in place to the charge station.

- 7 Press on the ON/OFF button 3 seconds to power ON the camera. Make sure that the battery is inserted correctly.

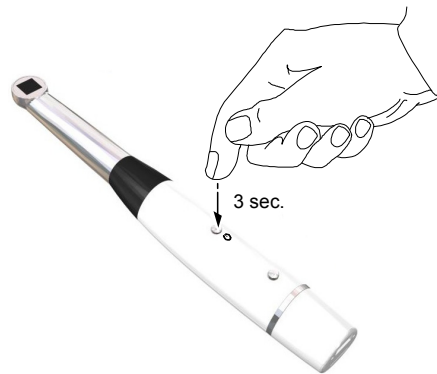

Using the Charge Station as a Stand-Alone Device

You can use the charge station as a stand-alone device placed on a table. Make sure to place it in a safe and clean place, free from water, fire, and any magnetic field.

To use the charge station as a stand-alone device, follow these steps:

- 1 Connect the power cable to the power input (A) of the charge station.
- 2 Connect the power plug to a wall outlet (B).

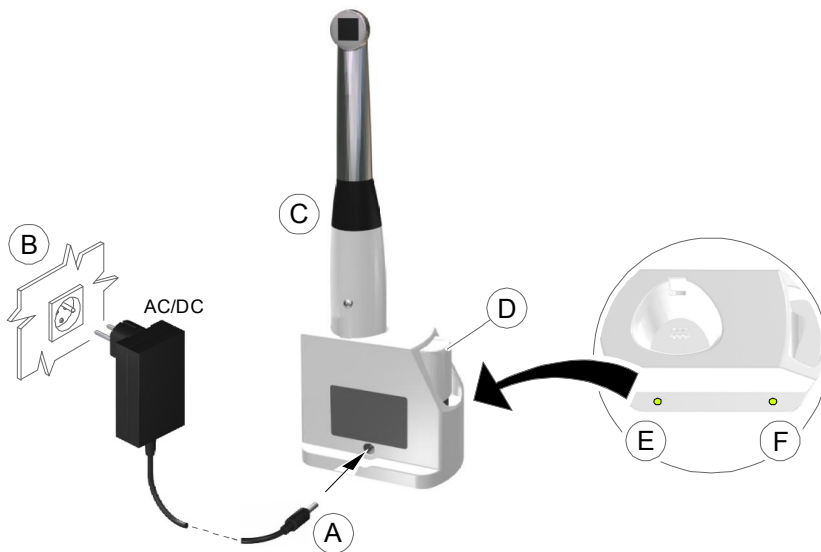

- 3 Insert the camera (C) and the additional battery (D) into the charge station.

The left LED indicator (E) displays the camera charging status; it becomes solid orange when charging is in process.

The right LED indicator (F) displays the camera charging status; it becomes solid orange when charging is in process.

The left (E) or right (F) LED indicators become solid green when the charge is complete.

Pairing the Wireless Camera to the Docking Station

Wireless cameras are paired at the factory to the docking station that is shipped with the camera.

You might have to pair a camera to a docking station again if

- You replace the original camera or the docking station.
- You want to use one camera with two or more docking stations that are connected to computers in individual operatories.



Important: The pairing of one camera to two or more docking stations can only be used when acquiring images using a computer, and not when acquiring images using a video monitor.

To pair the camera and the docking station, follow these steps:

- 1 Insert one end of the camera cable into the wireless camera and the other end of the cable into the docking station.

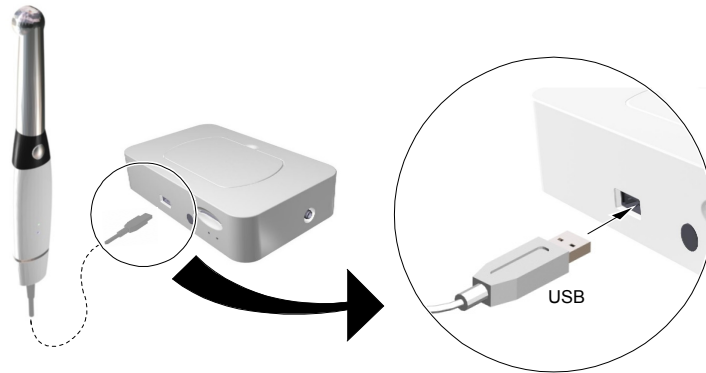

- 2 Insert the USB cable into the USB port of the docking station (A) and the other end into the USB port of the computer (B). Insert the DC power cable into the (C) docking station and the other end into the power outlet (D).

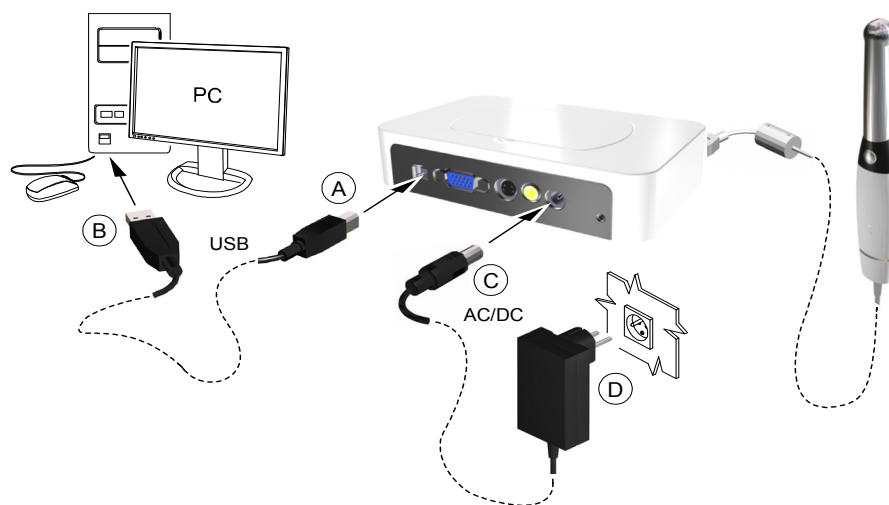

- 3 Power ON the camera.

- 4 Open the Dental Imaging Software and the **Acquisition** interface to see live video on the computer.
- 5 Perform the pairing by continuously pressing down on both the camera Power On button and the **Shutter Release** button for at least five seconds until the following message appears on the computer monitor: **Docking station and Camera have paired successfully.**

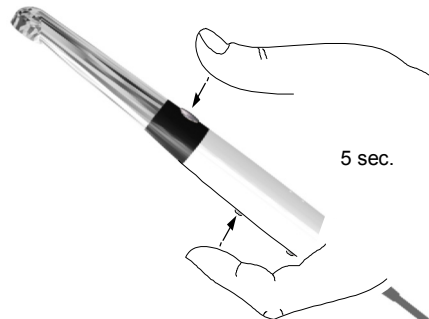

- 6 To pair the camera to additional docking stations, power off the camera, and repeat steps 1 to 5 for each docking station.



Important: You must connect each docking station to one specific computer, before pairing one camera to several docking stations.

- 7 After pairing the docking station, power off the camera and replace the camera cable with a charged battery.
- 8 Restart the camera and operate the camera in the wireless mode.

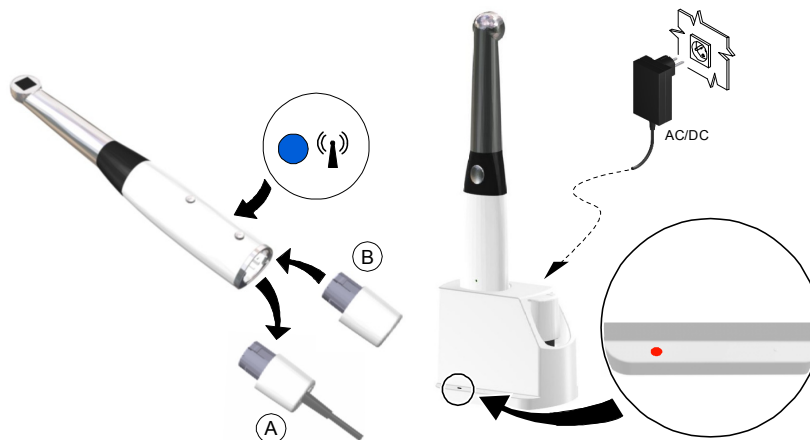

To use different computers for the CS 1500 wireless camera, see [“Acquiring Images Using Different Computers”](#).

Installing the Camera Holder

To install the camera holder, follow these steps:

- 1 Choose a clean area on the wall that you can access easily.
- 2 Clean the surface on which you are going to fasten the camera holder.
- 3 Remove the adhesive tape protection from the support (A).
- 4 Place the taped side of the camera holder on the clean surface (B) and press firmly several times for correct adherence. The maximum adherence is obtained after two hours.

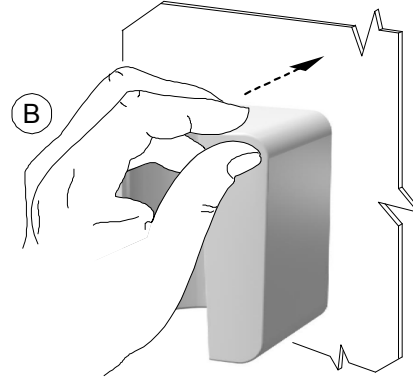
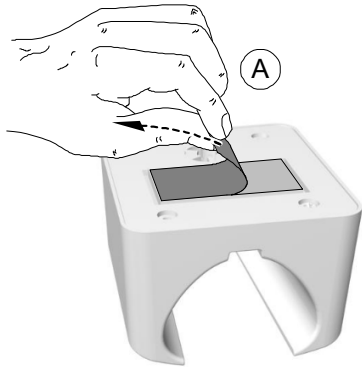

Important: You must avoid all stress on the camera holder during the first 2 hours.



Important: If you use the adhesive tape to fix the camera holder, it may not be secure enough after a certain time period. Check the adherence regularly to ensure that it is secure.



Important: Carestream Health is not responsible for damage from dropping the camera due to loosening of the adhesive tape.

- 5 For places on which you cannot use the adhesive tape, insert a screw through the appropriate hole in the camera holder and fix it to a solid surface.

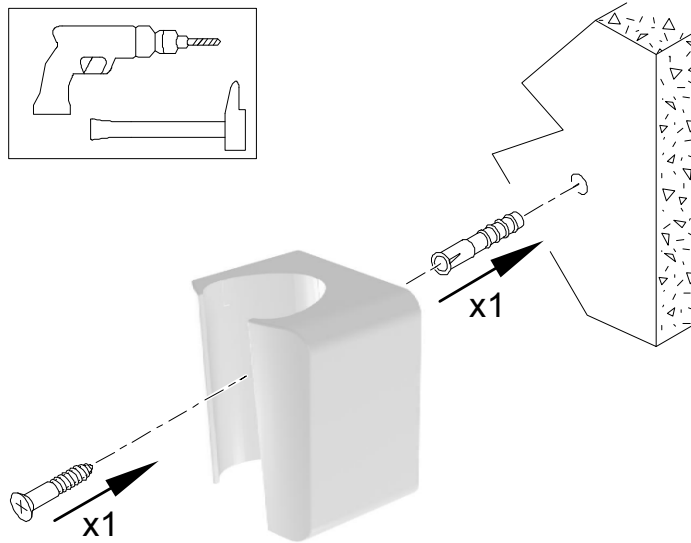

Note: The camera reverts to sleep mode when it is in the holder. If the camera is in the holder for more than 3 hours, it shuts down. To change the default automatic power-off time, see [“General Preferences”](#).

Connecting the Docking Station to a Video Monitor

To connect the docking station to a video monitor, follow these steps:

- 1 Using the switch at the bottom of the docking station, switch the output (A) to the correct video output: NTSC, PAL, VGA, or S-video.

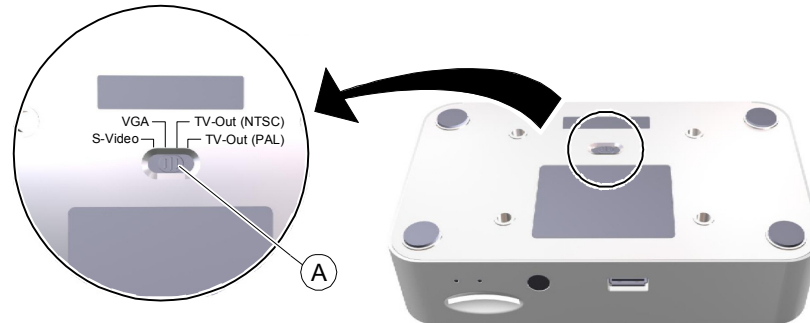

- 2 Select the correct video cable (see **"Packaging of CS 1500 Camera"**) and connect to the docking station: VGA (A) (not supplied), S-video (B), AV-out (C).

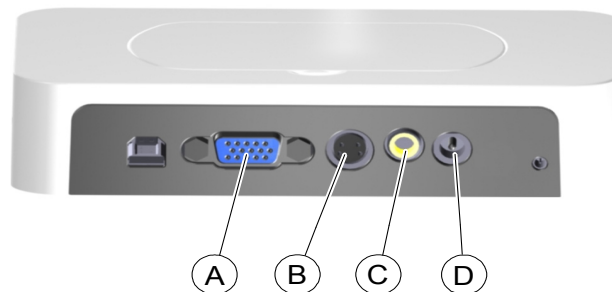

- 3 Connect the other end of the video cable to the monitor.
- 4 Connect the DC power supply to the docking station (D). Insert the DC power cord into the power outlet.

The power indicator on the front of the docking station turns green.

- 5 Insert the SD card into the socket on the front of the docking station (A).

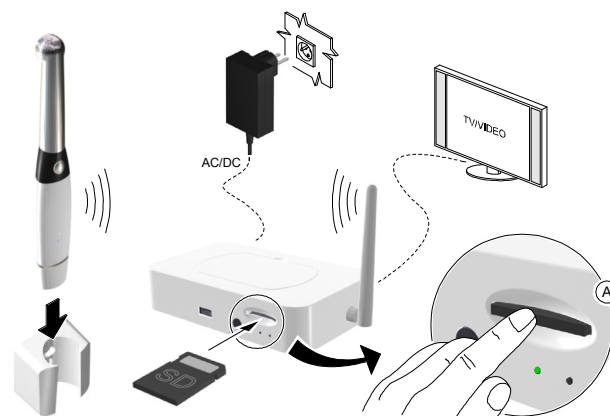

When the card is inserted, the images are transferred automatically to the card.

Without the SD card, or if the card is full, the docking station can store the last 12 images.







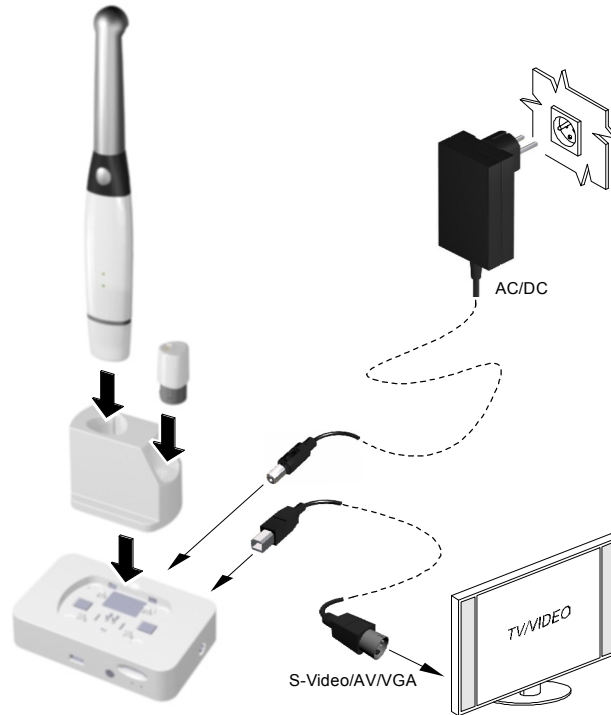









CAUTION: Do not remove the SD card while the docking station is accessing it. Wait until the SD card access icon at the lower-right of the monitor disappears.

Figure 13 Wireless Camera Connection to a Video Monitor Configuration



Video Monitor Equipment Status Icons





When using the camera and the docking station with a video monitor, the following icons are displayed on the video monitor to indicate equipment status:

	Firmware Update Error
	Firmware Update Successful
	Firmware Update in Progress
	No Connection between Docking Station and Camera
	Connection between Docking Station and Camera via USB
	Connection between Docking Station and Camera via WiFi
	WiFi Code is Successful
	WiFi Code Error
	SD Card is Not Inserted
	SD Card is Inserted
	SD Card is Full
	SD Card is Saving Files - Do Not Remove Card
	Error Saving File to Internal Flash or SD Card
	Saving to Internal Flash Successful
	Internal Cache is Full

6 Getting Started

Accessing the Acquisition Interface

To access the **Acquisition** interface, follow these steps:

- 1 In the **Imaging** window,
 - If you installed only the CS 1500, or you have installed the CS 1200 and/or CS 1600 camera before the CS 1500, click  or .
 - If you have installed a K 1000 camera before the CS 1500, click the arrow button on  or , and select the CS 1500 camera option from the drop-down list.

The **Acquisition** interface is displayed.







Note: When the icon with the number in the lower-right corner is displayed, the icon opens the last **Acquisition** interface used. To select another **Acquisition** interface, click the arrow button.

- 2 Select your preference settings.

Setting up Preferences

Set up your preferences before using the camera. To set up your preferences, follow these steps:

- 1 On the **Acquisition** interface, click  to access the preferences dialog boxes. The **Preference** dialog box is displayed.
- 2 Click  to set the **General Preferences**.
- 3 Click  to set the **Video Adjustment Preferences**.
- 4 Click  to select the **Tool Preferences**.

You can now capture images or record videos.

Using Imaging Software with TWAIN

Starting the Imaging Software

To acquire an image using imaging software via TWAIN, follow these steps:

- 1 From your imaging software, such as Photoshop, open the TWAIN interface. For example, in Photoshop, go to **Import > Select Source**.

The **Select Source** window is displayed.

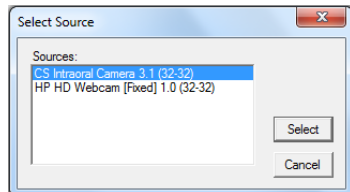

- 2 Select **CS Intraoral Camera 3.1 (32-32)**, and click **Select**.
- 3 Open the **Acquisition** interface using the TWAIN interface. See the user guide for your imaging software.



Important: The third party software used for image acquisition must be compliant with TWAIN.

TWAIN has the following limitations:

- TWAIN does not support the video file or tooth comment within the interface. The video file or tooth comment feature is disabled.
- After capturing images, click **Exit** to return to the third-party software interface. If the imaging software supports multiple image transfers, all images will be transferred.
- If the imaging software supports only single image transfer, either the first or the last acquired image will be transferred.



Note: If the message **Camera setting changed, please restart your third party software** is displayed, you must restart the software, then reopen the **Acquisition** interface.

Setting Up Preferences

Set up your preferences before using the camera. To set up the preferences, see [“Setting up Preferences”](#).

You can now capture images.

7 Recording Video and Capturing Images

Preparing for Acquisition

Preparing the Camera

The protective sheath covers the camera and provides a sanitary shield for the patient. **Use a new protective sheath with each patient. Always discard the protective sheath after each use.** For additional protective sheaths, contact your dealer or the protective sheaths manufacturer.



Important: Only use the protective sheaths designed specifically for this camera.

To prepare the camera, follow these steps:

- 1 Make sure the window is clean by wiping it with a moist lint-free cloth or lens tissue.
- 2 Place the protective sheath, paper side down, on a flat surface.
- 3 With the camera window facing down (A), insert the camera all the way into the protective sheath between the protective sheath's white tab and paper backing.

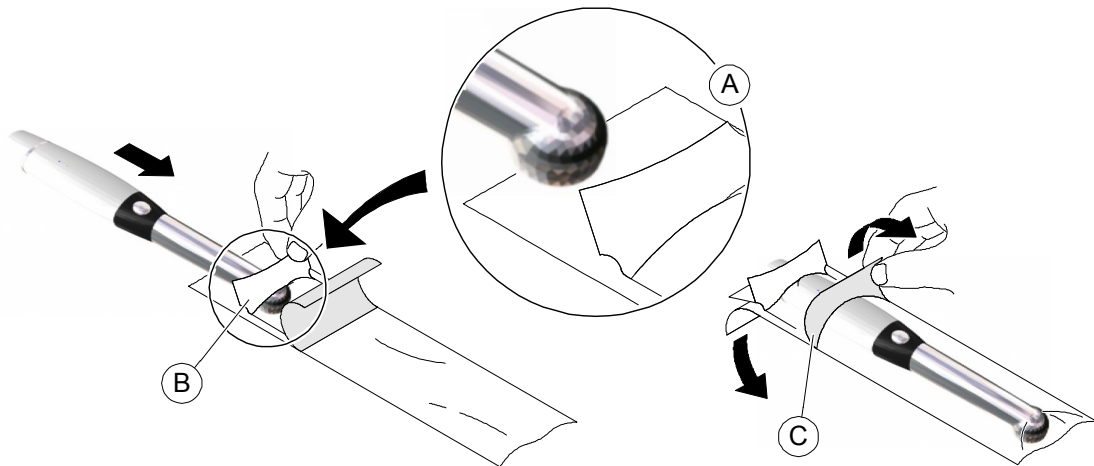

- 4 Hold the protective sheath in place on the camera by gently pressing the white tab against the camera with your thumb (B).
- 5 Pull the blue tab on the front of the protective sheath straight down away from the camera (C) until the paper backing is pulled away. Discard the paper backing, leaving the clear plastic protective sheath on the camera.
- 6 Adjust the protective sheath if necessary. The end should be tight to prevent fogging or blurring of the image.



Note: Installing the sheath incorrectly has a negative effect on image quality.

Recording Video and Capturing Images on a Computer

Recording and Viewing Videos

To record or view a video, follow these steps:

- 1 Hold the camera over the area you want to view.

Live video appears on the **Preview** screen.

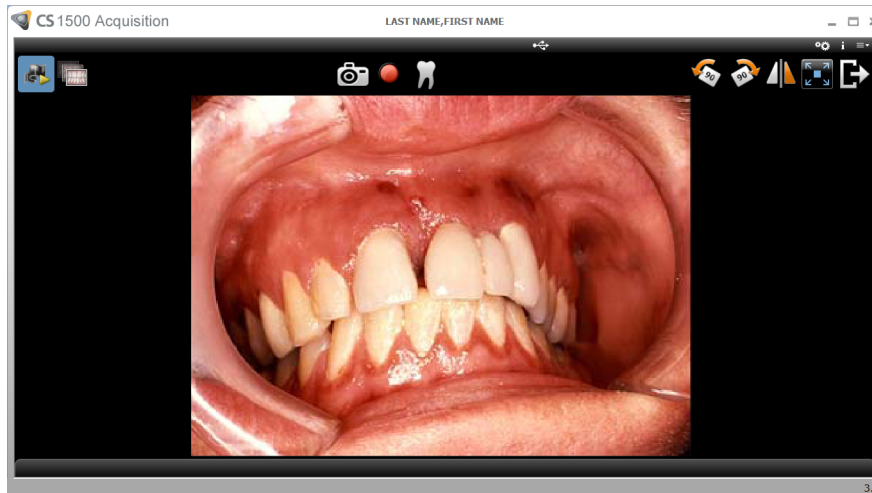

- 2 To record the video, on the **Acquisition** interface, click  to record and click again to stop the recording.

The **Preview** screen of the **Acquisition** interface shows the video recording.

- 3 Use the video toolbar to view the recorded video (see "[Video Toolbar](#)").
- 4 Use the image gallery toolbar to navigate or to delete the recorded video (see "[Image Gallery Toolbar](#)").
- 5 Click  to close the **Acquisition** interface and return to the imaging software interface.

The recorded video is saved and displayed in the **Patient history**.

- 6 Remove and dispose of the protective sheath.



Note: If the camera is idle for 1.5 minutes, it switches to sleep mode. To use it again, pick it up or press the **Shutter Release** button.



Note: When the camera is idle for more than 3 hours, it shuts down. To change the default automatic power-off time, see "[General Preferences](#)".

Capturing and Viewing Images

To capture or view an image, follow these steps:

- 1 Hold the camera over the area you want to view.
Live video appears on the **Preview** screen.

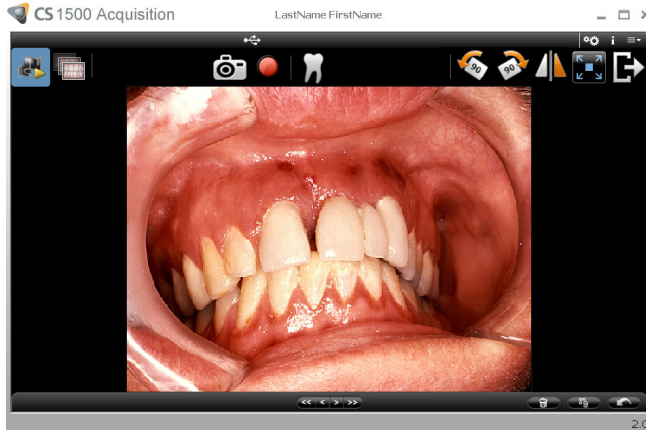

- 2 To capture an image, do the following:
Press the **Shutter Release** button on the camera.

OR

Click  on the **Acquisition** interface.

The **Review** screen of the **Acquisition** interface shows the image.



- 3 Click  to access the **Tooth Chart** dialog box and select the relevant tooth and write comments in the **Comments** field (see ["Tooth Chart Dialog Box"](#)).
The selected images are displayed and saved temporarily in the image gallery.
- 4 Use the toolbar to view the image (see ["Image Toolbar"](#)).

- 5 Use the image gallery toolbar to navigate or to delete the still images (see ["Image Gallery Toolbar"](#)).
- 6 Press the **Shutter Release** button halfway down and release it to return to the **Preview** window.
- 7 Click  to close the **Acquisition** interface.

The recorded video is saved and displayed in the **Patient history**.

- 8 Remove and dispose of the protective sheath.



Note: If the camera is idle for 1.5 minutes, it switches to sleep mode. To use it again, pick it up or press the **Shutter Release** button



Note: When the camera is idle for more than 3 hours, it shuts down. To change the default automatic power-off time, see ["General Preferences"](#).

Acquiring Images Using Different Computers



Important: Acquiring images using different computers can only be performed if you have paired one camera to 2 or more docking stations (see ["Pairing the Wireless Camera to the Docking Station"](#)).

If you want to acquire images using different computers, follow these steps:

- 1 Select the computer connected to the idle docking station for image acquisition.
- 2 Click the switch button on the **Acquisition** interface. The idle computer becomes active.
- 3 To record a video or capture an image, see ["Recording and Viewing Videos"](#) or ["Capturing and Viewing Images"](#).



Note: The status of the previously used computer is changed from active to idle.

Acquiring Images Using a Video Monitor

When you acquire images using the camera with a video monitor, you can view live video and captured images. You can store up to 12 images in the docking station or an additional 10,000 or more images on the SD card in the docking station.

If you want to manipulate, label, or store images, move the images from the SD card to your computer, and then view them using any software capable of viewing **.jpg** images.

To acquire images using a video monitor, follow these steps:

- 1 Hold the camera over the area you want to view. Live video appears on the video monitor.
- 2 Press the **Shutter Release** button on the camera to capture an image. The still image appears on the video monitor (see [“Wireless Camera Overview”](#)).
- 3 Press the **Shutter Release** button on the camera half-way down, and release it to view live video on the video monitor.
- 4 When image acquisition is completed, remove and dispose of the protective sheath.

8 Maintenance

Perform the following maintenance activities on your camera and accessories regularly.

The camera is not delivered in disinfected condition. To ensure maximum hygienic safety for the patient, carefully follow the instructions to disinfect the camera before use.



Important: Before following the maintenance instructions, make sure that you have read the **Safety Sheet** and the **Safety and Regulatory guide**.

Cleaning and Disinfecting

You must clean and disinfect the CS 1500 and accessories regularly.



Important: For more information on cleaning and disinfecting the equipment, see the **CS 1500 Intraoral Camera Safety & Regulatory Guide**.

9 Contact Information

Manufacturer's Address



Carestream Health, Inc.
150 Verona Street
Rochester, NY USA 14608

Authorized Representatives

Authorized Representative in the European Community

EC REP

Carestream Health France
1, rue Galilée
93192 Noisy-Le-Grand Cedex, France

Importer for European Union

Carestream Health Netherlands B.V.
Bramenberg 12
3755 BZ Eemnes
The Netherlands

Representante no Brasil Carestream do Brasil Comércio e Serviços de Produtos Médicos Ltda.

Rua Pequetita, 215 cjs.
31 E 32 Edifício Atrium VII - Vila Olímpia
São Paulo - Brazil
CEP (Zip code): 04552-060

Carestream Dental

A Division of Carestream Health, Inc.
150 Verona St.
Rochester, NY 14608
USA

For more information, visit: www.carestreamdental.com
To give documentation feedback, visit:
www.carestreamdental.com/documentationfeedback