



Instructions for Use

A-dec 311 Dental Chair

Copyright

© 2013 A-dec Inc. All rights reserved.

A-dec Inc. makes no warranty of any kind with regard to this material, including, but not limited to, the implied warranties of merchantability and fitness for a particular purpose. A-dec Inc. shall not be held liable for any errors contained herein or any consequential or other damages concerning the furnishing, performance or use of this material. The information in this document is subject to change without notice. If you find any problems in the documentation, please report them to us in writing. A-dec Inc. does not warrant that this document is error-free.

No part of this document may be copied, reproduced, altered, or transmitted in any form or by any means, electronic or mechanical, including photocopying, recording, or by any information storage and retrieval system, without prior written permission from A-dec Inc.

Trademarks and Additional Intellectual Property Rights

A-dec, the A-dec logo, A-dec 500, A-dec 300, Cascade, Cascade Master Series, Century Plus, Continental, Decade, ICX, ICV, Performer, Preference, Preference Collection, Preference ICC, and Radius are trademarks of A-dec Inc. and are registered in the United States and other countries. A-dec 400, A-dec 200, Preference Slimline, and reliablecreativesolutions are also trademarks of A-dec Inc. None of the trademarks or trade names in this document may be reproduced, copied, or manipulated in any manner without the express, written approval of the trademark owner.

Certain touchpad symbols are proprietary to A-dec Inc. Any use of these symbols, in whole or in part, without the express written consent of A-dec Inc., is strictly prohibited.

Regulatory Information

The *Regulatory Information and Specifications* document is delivered with A-dec dental device equipment as mandated by agency requirements. If you need this information, please go to the Document Library at www.a-dec.com.

Product Service

Product service is available through your local authorized A-dec dealer. For service information, or to locate an authorized dealer, contact A-dec at 1.800.547.1883 in the USA and Canada or 1.503.538.7478 worldwide, or visit www.a-dec.com.

Content Map

Headrest.....6

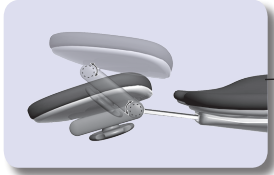

Barriers.....9

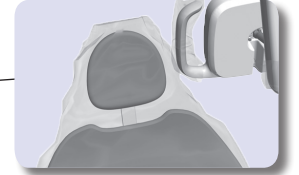

Armrests.....8

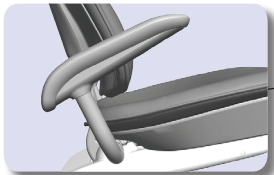

Utilities.....11

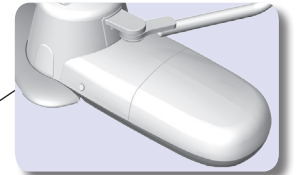

Footswitch.....4

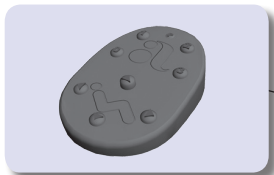

Power Button.....2

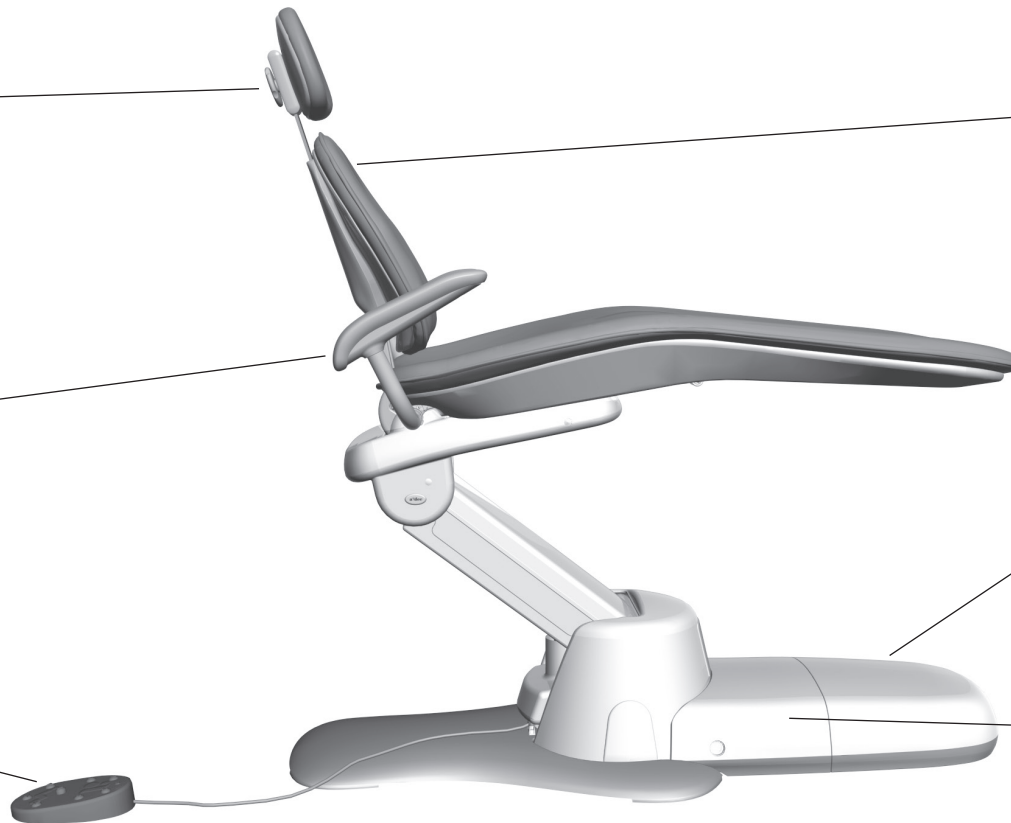
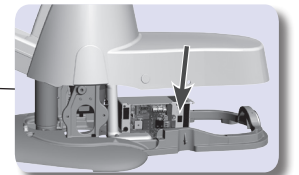

Operate / Adjust	2
Clean / Maintain.....	9
Specifications and Warranty.....	12

Operate / Adjust

Power On/Off

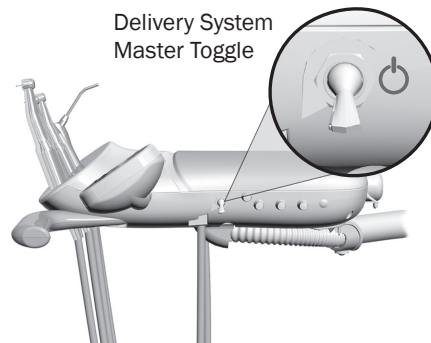
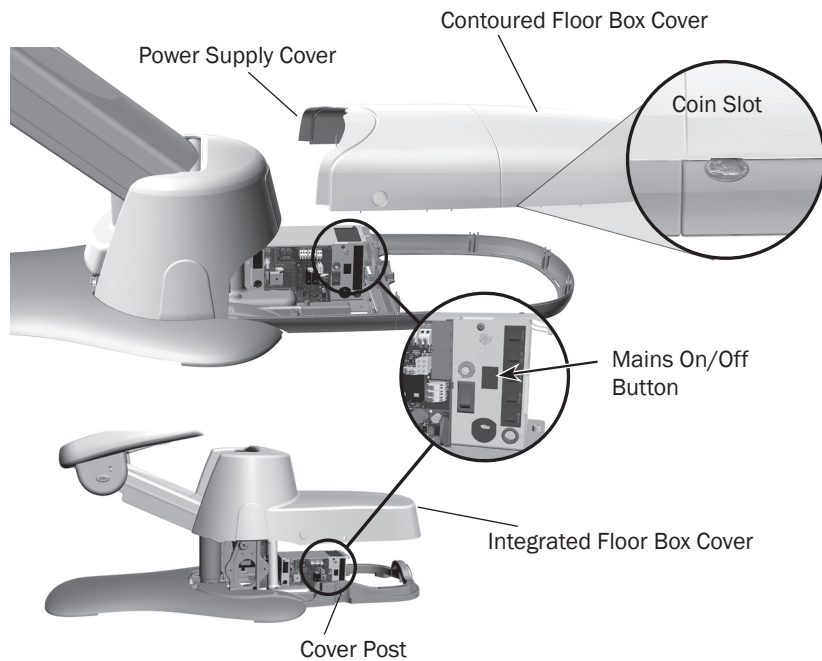

Chair-Only Configurations

For chair-only configurations, press the mains on/off button in to turn the power on or off. To access the mains button on chairs with a contoured floor box, first remove the front floor box cover. If needed, use a large coin in the integrated coin slot to gently separate the floor box cover from the frame. Then remove the power supply cover.



NOTE Take care not to damage the cover when using the coin slot.

On chairs with an integrated floor box, gently pull out at the cover posts and lift off the cover.



CAUTION When removing or replacing covers, take care not to damage any wiring or tubing. Verify that the covers are secure after replacing them.

Chairs with Delivery and Support Systems

If you have a chair with an attached system, use the master toggle to turn the power on or off. The master toggle is normally located on the delivery system, but may instead be located on the support center or floor box on chairs without a delivery system. If there is no power to the system, verify that the mains on/off button is in the on position (pressed in). The mains power must be on in order for the master toggle to control system power.

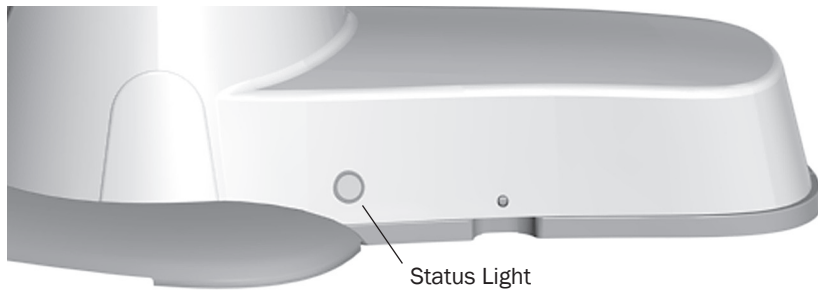

Chair Status Light

When the chair status light illuminates solid blue, the chair is on and ready for use. See below for other indications.

Light Status	Description and Action
Solid Blue	Normal operation. Proceed as normal.
Blinking	Chair back has exceeded the run time limit. Wait for one minute, then proceed as normal.
Double Blink	Chair is in factory default. Programmed pre-sets are disabled, but all other functions are normal. Call for service.

When to Turn Off the Power

To save energy, turn off the power at the end of the work day and during longer periods of non-use.

Touchpad Chair Controls



Chair functions work similarly whether you have an A-dec touchpad or footswitch. To use and program chair functions on the touchpad, please see the Instructions For Use that came with your delivery system.

Footswitch Chair Controls

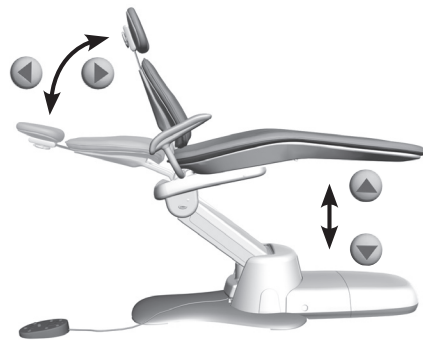
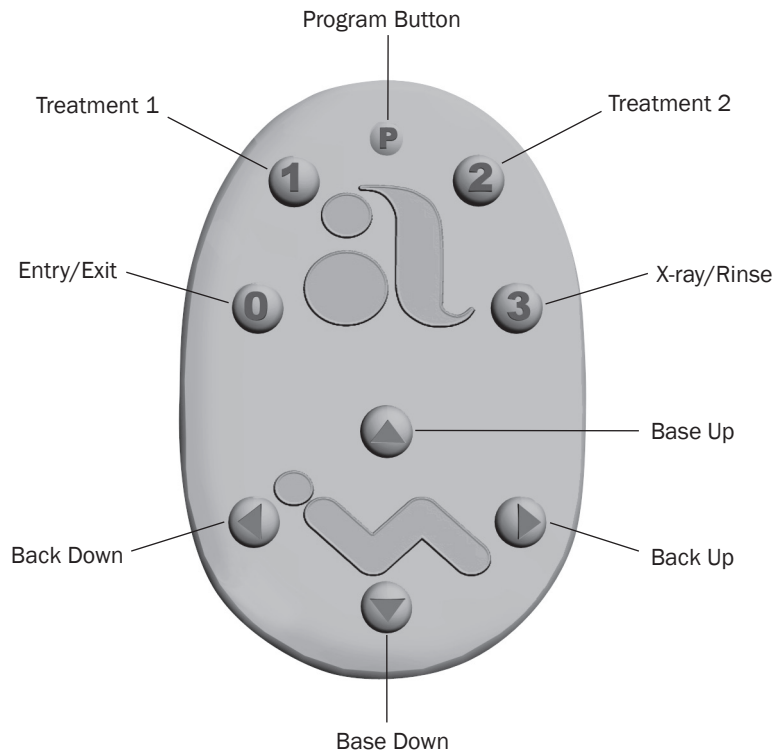

The chair footswitch allows you to operate the chair manually or by using the programmed preset buttons 0, 1, 2, and 3.

Programmed Control



NOTE Please follow standard patient care precautions when using the chair preset position functions. Always take extra care with small children and patients with limited mobility.

To stop the chair at any point, push any chair positioning button on the footswitch or touchpad.

On the footswitch, use the numbered buttons for programmed control of the chair:

Icon	Position	Factory Setting
P	n/a	Initiates programming of preset positions.
0	Entry/Exit	Positions the chair for patient entry/exit.
1	Treatment 1	Positions the chair base and back down.
2	Treatment 2	Positions the chair base down and back up.
3	X-ray/Rinse	Moves the chair to either x-ray or rinse position. Press again to move the chair to the previous position.

Manual Control

Use the arrow buttons to manually position the chair back and base.

Footswitch Chair Controls *(continued)*

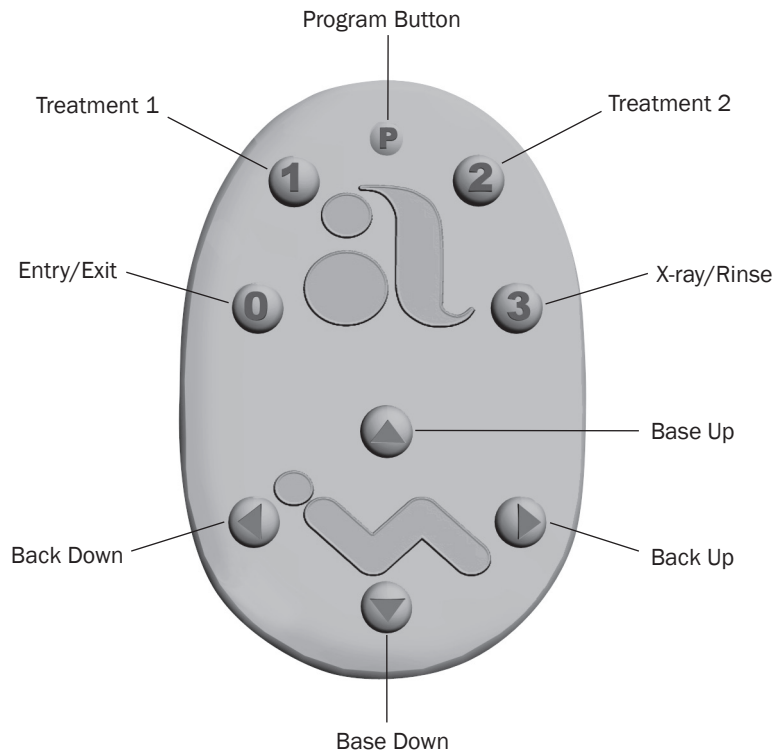

Chair Preset Buttons

To program the chair presets Entry/Exit, Treatment 1, and Treatment 2:

1. Use the manual controls to adjust the chair position as desired.
2. Press and release **P**. One beep indicates that the programming mode is on.
3. Within five seconds, press the chair position button you wish to reset (for example, press **1**). Three beeps indicates that the new setting is programmed into memory.

X-Ray/Rinse Button

The x-ray/rinse button (**3**) is preset to move the chair and patient into an upright position for x-rays or cuspidor access. A second press of this button returns the chair to the previous position.

The x-ray/rinse button can be reprogrammed as another preset position. To change the function of the x-ray/rinse button:

1. Press and hold **P** and **3** at the same time for three seconds.
 - One beep indicates the button is set as an additional programmable preset position.
 - Three beeps confirm that the button is configured as the x-ray/rinse function set at the factory (toggles between the x-ray/rinse and the previous position).
2. If you want to assign a different chair location for the x-ray/rinse preset, follow the steps outlined in "Chair Preset Buttons" above.

Double-Articulating Gliding Headrest

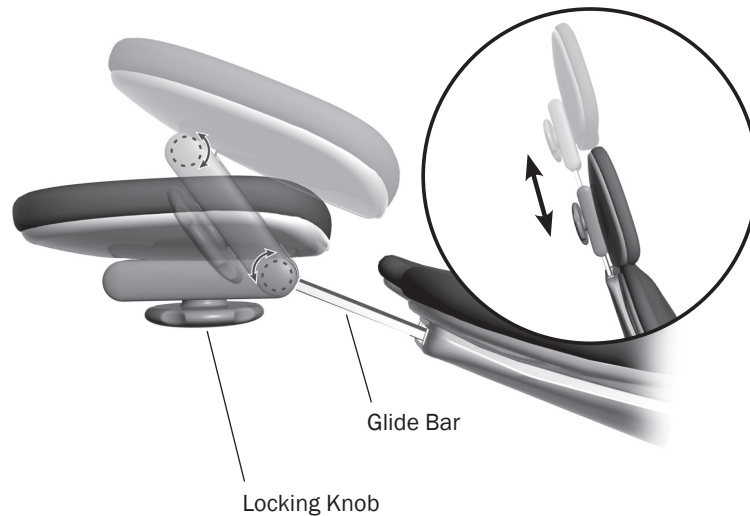

The double-articulating headrest includes several adjustment features that improve your access to the oral cavity and increase patient comfort.

Use the glide bar to accommodate a variety of patient heights. Simply pull up or push down on the headrest until it is in the desired position. The gliding headrest cushion provides additional height adjustment.



CAUTION When the glide bar has reached its maximum recommended working height, a warning will be visible on the patient's side of the glide bar. Do not use the headrest in a position where this warning is visible.

The locking knob allows you to easily adjust the headrest for a full range of positions. Release the headrest by turning the locking knob counterclockwise, then adjust the headrest for a proper fit. Lock the headrest in the desired position by turning the knob clockwise.

Headrest Glide Bar Tension

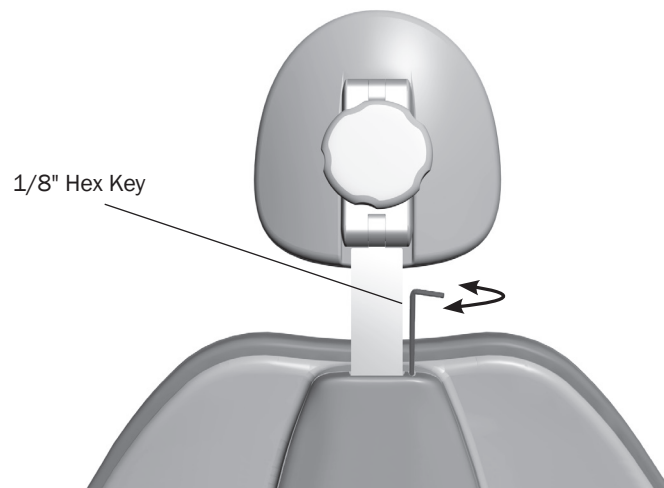

If the headrest drifts downward, or if it is difficult to move up or down, the glide bar tension needs adjustment.

To adjust the tension, use a 1/8" hex key. Turn the tension adjustment screw clockwise to increase friction or counterclockwise to decrease friction.

Headrest Position for Wheelchairs

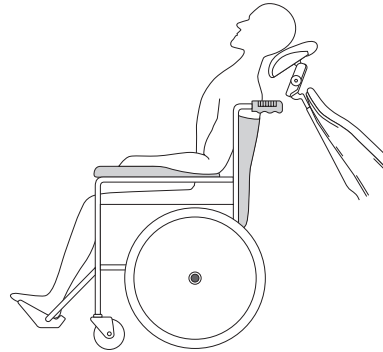

The double-articulating headrest can be used to accommodate patients in wheelchairs. To position the headrest for wheelchairs:

1. Slide the headrest glide bar up until it is free from the dental chair.
2. Rotate the headrest 180° and slide the glide bar into the backrest. Ensure that the glide bar is pushed completely into the backrest.
3. Position the backrest to its full-up position.
4. Place the wheelchair and the dental chair back to back to position the patient. Adjust the headrest height by moving the dental chair up or down.
5. Ensure that the wheels of the wheelchair are locked.

Patient-Adjustable Neck Support

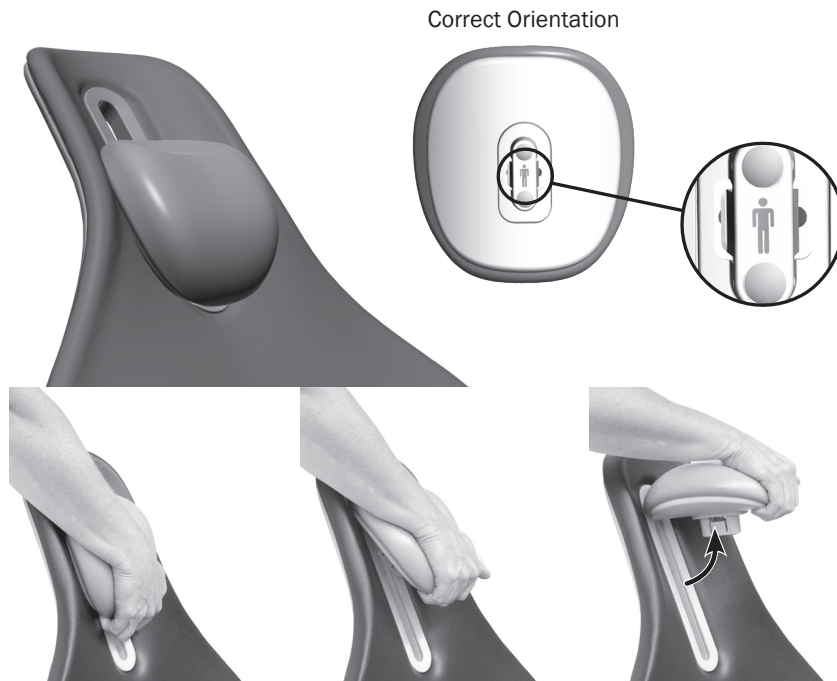

On backrests with the integrated neck support, ensure that the cushion is in the correct position as the patient is seated. Place the cushion below the occipital bone for optimal patient comfort. Properly positioned, the cushion glides with the patient as the chair back is raised or lowered.

The neck support can be removed for cleaning or to accommodate small children. To remove, grasp the back of the neck support firmly and pull the cushion out of the track. To reinstall, press the neck support into the track until it snaps into place. Be sure the cushion is oriented correctly. An illustration on the back shows the correct orientation.

Patient Positioning



To properly seat patients in the chair, ask the patient to sit as far back in the seat pocket as possible. This ensures the best alignment with the lumbar support and headrest.

For optimal comfort, patients should place their forearms on the armrests or keep their arms comfortably folded on their lap.



WARNING Do not allow patients to drop their arms behind the armrests or under the backrest during chair movement. Always take extra care with small children and patients with limited mobility.

Armrests

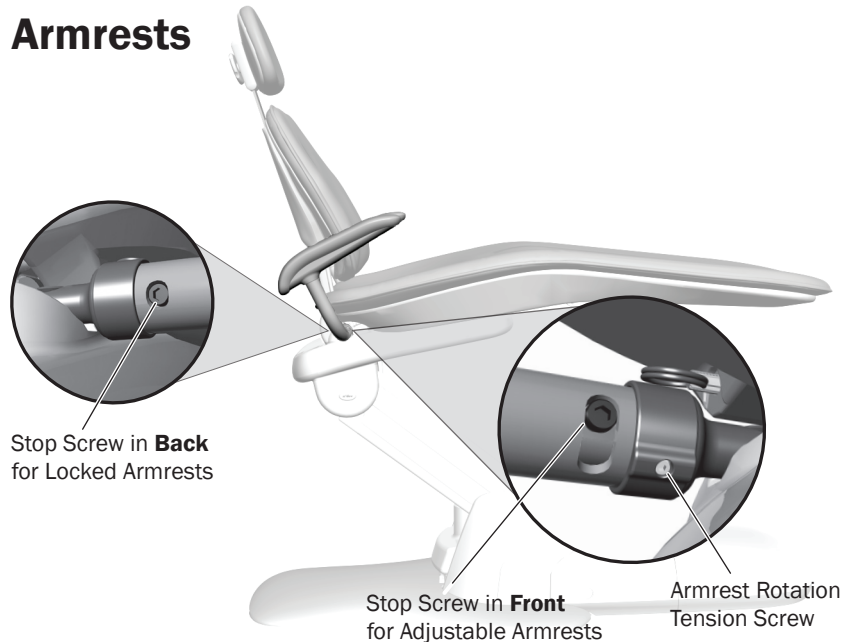

Armrest Rotation

The armrests come locked from the factory, but can be unlocked to allow for easier patient entry/exit and to improve operator access while working direct. To unlock the armrests, use a 3/16" hex key to remove the stop screw from the back of the armrest. Install the stop screw in the front of the armrest.

Armrest Rotation Tension Adjustment

If the unlocked armrests become loose or are difficult to move, you can adjust the rotation tension. Use a 1/8" hex key and turn clockwise to tighten or counterclockwise to loosen the rotation tension screw.

Clean / Maintain

Barrier Protection

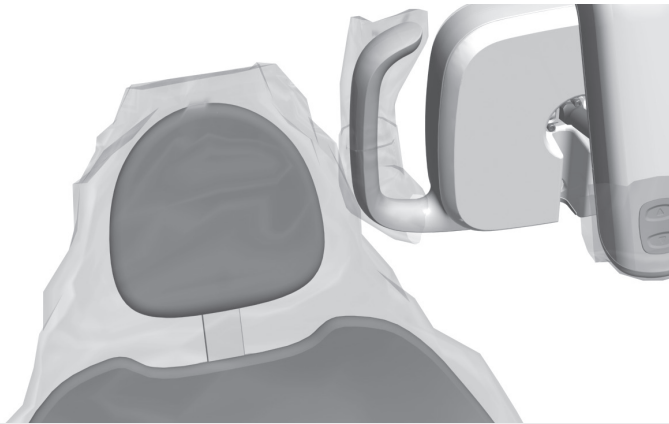

CAUTION If you use barriers, always replace the barrier film after each patient.



IMPORTANT For recommendations on cleaning and chemical disinfection of touch and transfer surfaces (where barrier protection is not applicable or when barriers are compromised), please see the *A-dec Equipment Asepsis Guide* (p/n 85.0696.00) included with your equipment.

A-dec recommends barrier protection for all applicable touch and transfer surfaces. Touch surfaces are areas that come into contact with hands and become potential cross-contamination points during dental procedures. Transfer surfaces are areas that come into contact with instruments and other inanimate objects.

In the USA, barriers must be produced under the Current Good Manufacturing Practice (CGMP) as specified by the U.S. Food and Drug Administration (US FDA). For regions outside the USA, refer to the medical device regulations specific to your location.

Upholstery

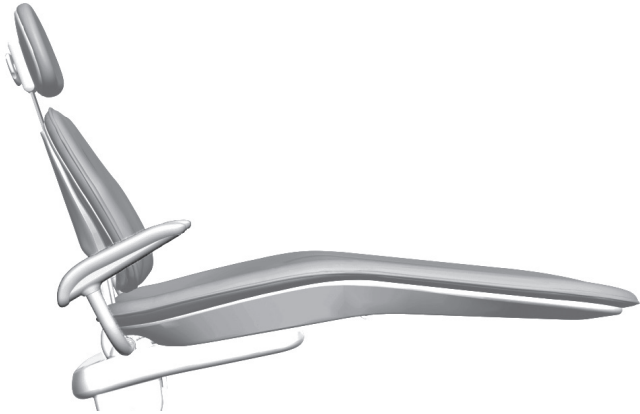

To preserve the quality of your A-dec upholstery, use barrier covers instead of relying on chemicals. Barriers significantly extend the life of the upholstery and will help to preserve its luxurious look and soft feel. To clean the upholstery, use a solution of mild detergent and water. Use surface disinfectants only when the barriers have been compromised or if there is visible spatter on the upholstery.



CAUTION Minimize the use of surface disinfectants on the upholstery. Chemicals can cause deterioration and shorten the life of upholstered surfaces. For recommendations on maintaining your A-dec upholstery, see the *Upholstery Maintenance Guide* (p/n 86.0501.00), which is located on www.a-dec.com.

Toeboard Cleaning

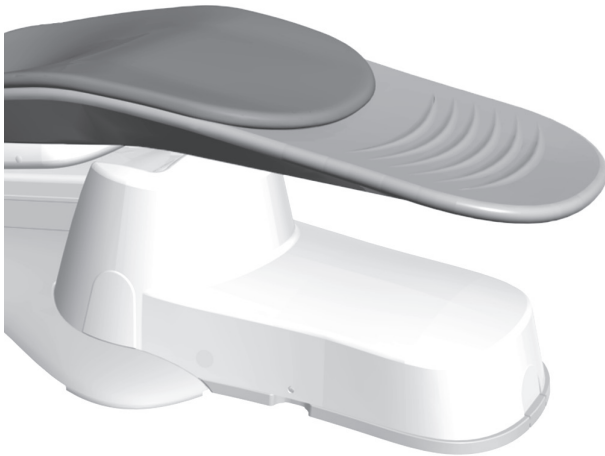

To remove scuffs, scrapes, and stains from the non-upholstered portion of the toeboard (if applicable), follow these steps:

1. Remove the vinyl toeboard cover.
2. Wet the foot area with water from a spray bottle or wet towel.
3. Apply a mildly abrasive kitchen or bath cleanser. Follow the manufacturer's instructions.
4. Use a soft towel to rub the cleanser in a circular motion over the entire surface.
5. Remove the cleanser with clean water and a clean towel.
6. This process may be repeated for blemishes that require additional cleaning.

Utilities

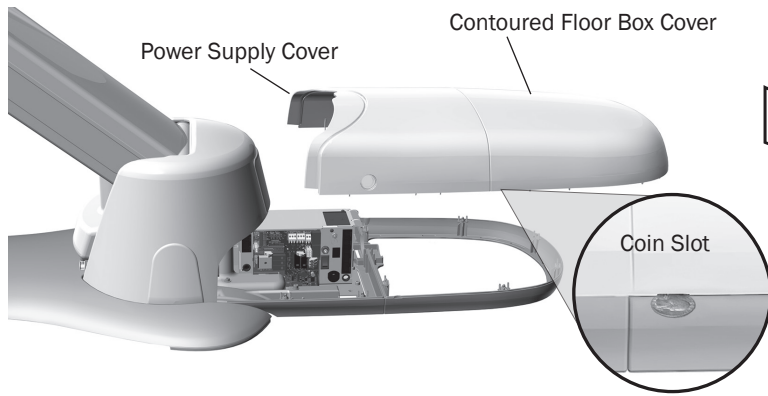

The utilities for A-dec chair-mounted delivery systems are located in the contoured or integrated floor box under your chair. To maintain these utilities, see the Instructions For Use that came with your system. If you have a chair-only configuration, you may still have a floor box that hides the power cord and outlet. For access, lift the cover up and off the floor box frame. If needed, use a large coin in the integrated coin slot to gently separate the floor box cover from the frame. Then remove the power supply cover.



NOTE Take care not to damage the cover when using the coin slot.

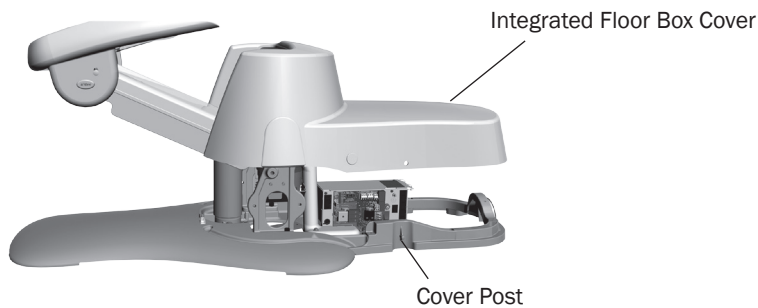

On chairs with an integrated floor box, gently pull out at the cover posts and lift off the cover.



CAUTION When removing or replacing covers, take care not to damage any wiring or tubing. Verify that the covers are secure after replacing them.

Specifications



Maximum Chair Capacity

Patient Load: 400 lb (181 kg)



IMPORTANT For chair accessory load capacity, electrical specifications, identification of symbols, and other regulatory requirements, refer to the *Regulatory Information and Specifications* document (p/n 86.0221.00) included with your equipment.



NOTE Specifications are subject to change without notice. Requirements may vary depending on your location. For more information, contact your authorized A-dec dealer.

Warranty

A-dec warrants all products against defects in materials or workmanship for one year from time of delivery. A-dec's sole obligation under the warranty is to provide parts for the repair, or at its option, to provide the replacement product (excluding labor). The buyer shall have no other remedy. All special, incidental, and coincidental damages are excluded. Written notice of breach of warranty must be given to A-dec within the warranty period. The warranty does not cover damage resulting from improper installation or maintenance, accident or misuse. The warranty does not cover damage resulting from the use of cleaning, disinfecting or sterilization chemicals and processes. The warranty also does not cover light bulbs. Failure to follow instructions provided in the A-dec Instructions For Use (operation and maintenance instructions) may void the warranty.

A-dec warrants A-dec dental chair cylinders, both lift and tilt for ten years from the date of purchase of the chair or the cylinder. This warranty is retroactive to A-dec chair cylinders already in the field. The warranty covers chair cylinders A-dec finds to have manufacturing irregularities. Stool cylinders are covered under A-dec's one-year warranty. No other warranties as to merchantability or otherwise are made. For service information, contact your local authorized A-dec dealer. Check with local codes and the Americans with Disabilities Act (ADA) requirements for installation of this product.



CAUTION U.S. Federal law restricts this device to sale by or on the order of a dentist, physician, or any other practitioner licensed by the law of the state in which he or she practices to use or order the use of this device.



A-dec Headquarters

2601 Crestview Drive
Newberg, OR 97132
USA

Tel: 1.800.547.1883 Within USA/Canada
Tel: 1.503.538.7478 Outside USA/Canada
Fax: 1.503.538.0276
www.a-dec.com

International Distribution Centers

A-dec United Kingdom

EU Authorized Representative
Austin House, 11 Liberty Way
Nuneaton, Warwickshire CV11 6RZ
England
Tel: 0800 ADECUK (233285) Within UK
Tel: +44 (0) 24 7635 0901 Outside UK
www.a-dec.co.uk

A-dec Australia

Unit 8
5-9 Ricketty Street
Mascot, NSW 2020
Australia
Tel: 1.800.225.010 Within Australia
Tel: +61 (0)2 8332 4000 Outside Australia
www.a-dec.com.au



86.0093.00 Rev D
Copyright 2013 A-dec Inc.
All rights reserved.